

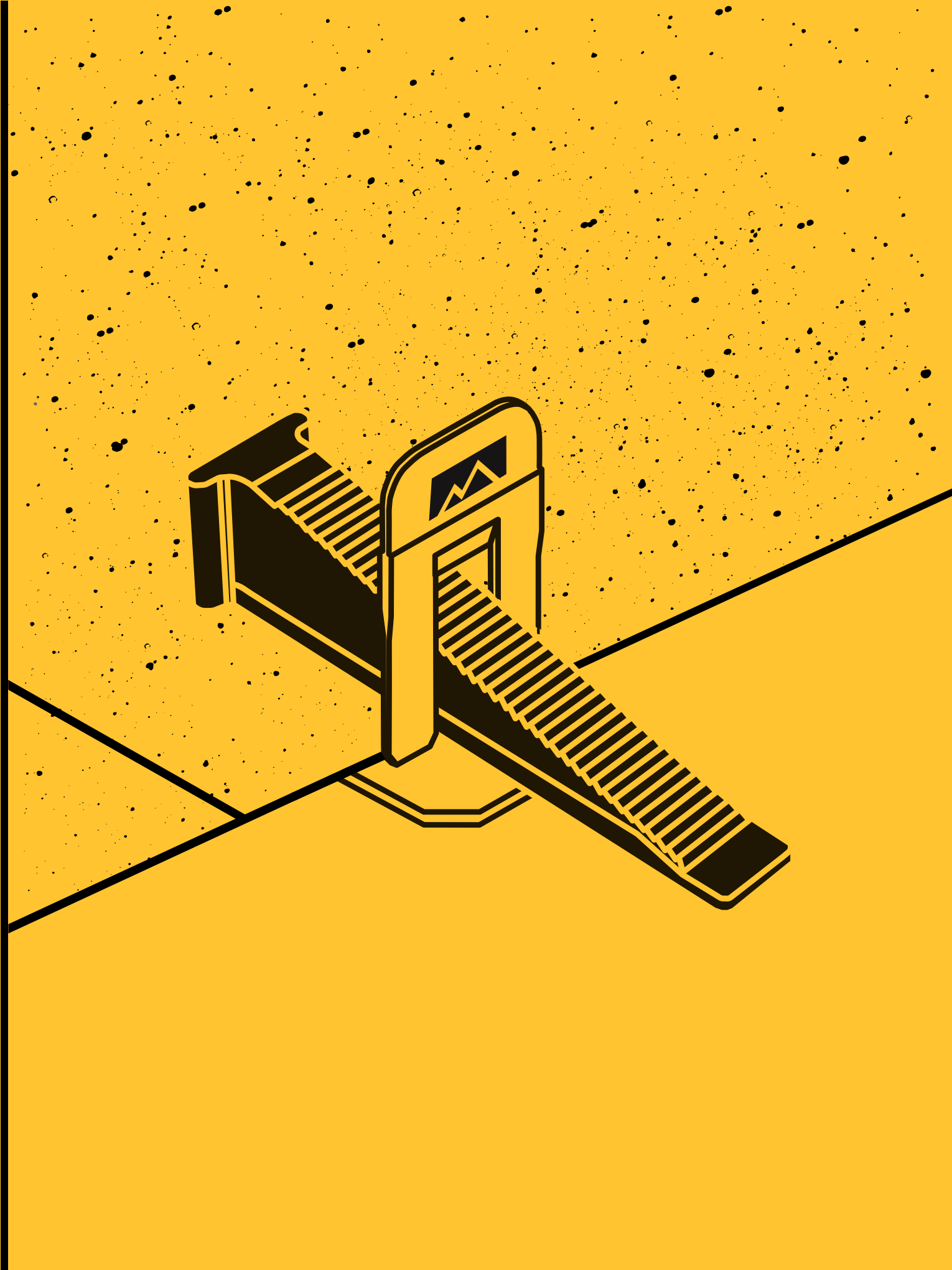

undertag
tile leveling system



www.undertag.pl

ABOUT US

ARS Company produces license plate frames and tile leveling systems.

TLS-Profi and UNDERTAG tile leveling systems are already presented in more than 250 companies both on CIS and European markets. This is not a coincidence since our system allows absolutely everyone to achieve professional results.

The company has its own raw material base and injection molding machines. The core of the company is its employees. We strive to provide best quality products and high customer service for all our clients.



PRODUCTION

ARS Company has been specializing in manufacturing of high quality plastic products for over 20 years. Our production site is 5000 sq. m. which includes production area, warehouses and office spaces. We have fully perfected the entire production process from recycling plastic to molding to packaging and shipping around the world. Our current production capacity is 1 million clips and 300 000 wedges per day. German and Polish technologies are used in production.



ABOUT THE TILE LEVELING SYSTEM

Professionals all throughout CIS, Europe and USA already use our systems as an indispensable tool when working with tiles.

Our system is essential for:

- laying large format tiles
- laying tiles over a large area

Recommended for:

- all types of tiles

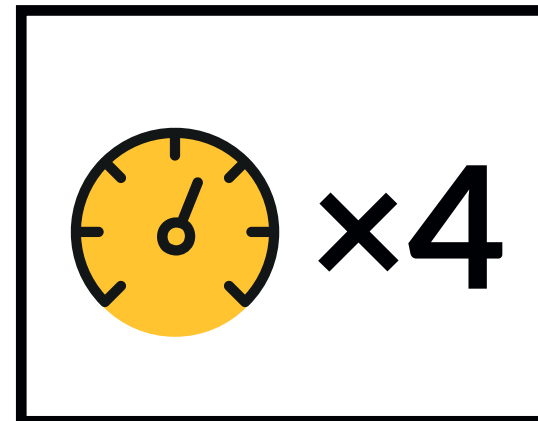

Reduce laying time

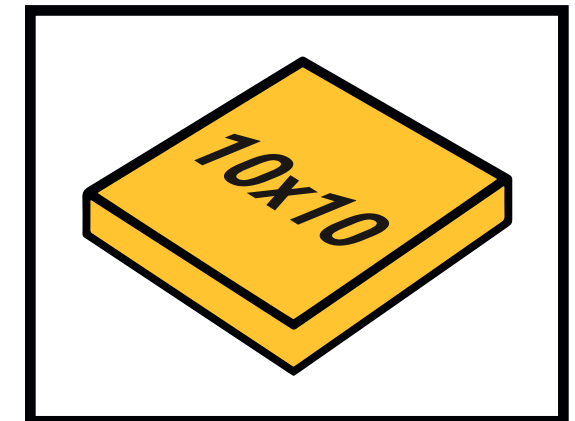

Recommended for all tile formats from 10x10 cm

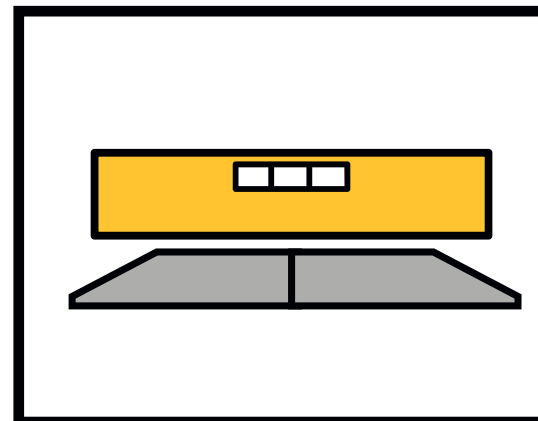

Get perfect surface of the tile

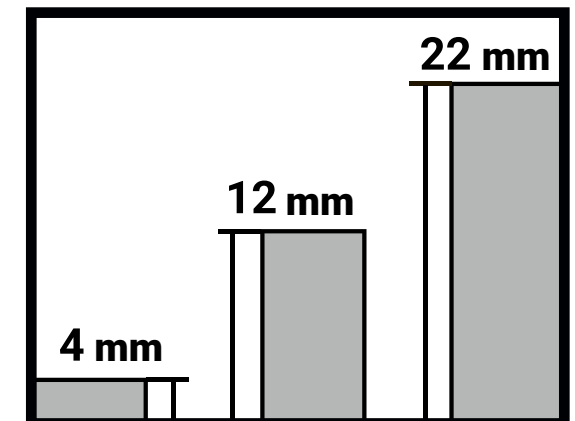

For tile thickness from 4 to 12 mm and 12 to 22 mm

CLIPS 0.5 MM FOR NARROW GROUT LINES

Product code	Name	Thickness of the clips	Units per bag	Bags per box	Dimensions of the box, cm	Weight of the box, kg	Barcode
LVL62020	Clips	0.5 mm	100 pcs	20	39.5 x 19.5 x 15.5	2.9	5903796787269

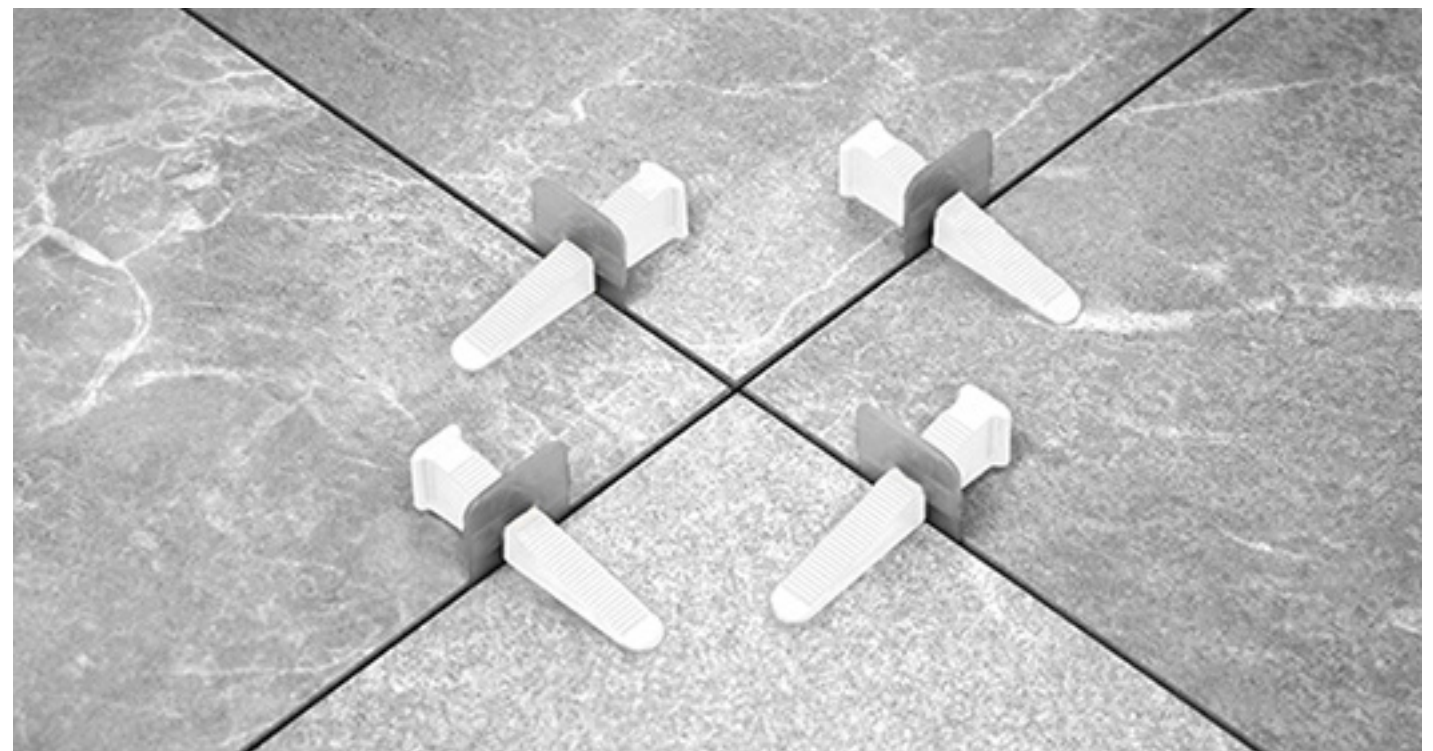
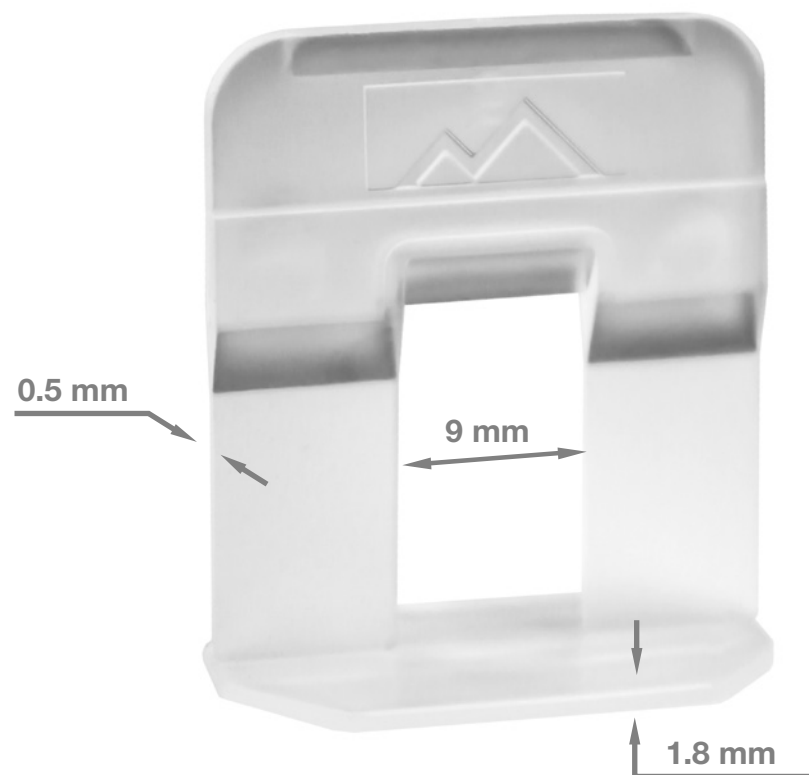

- Do not break during installation and easily break off using a mallet after tiling

- Thin 1.8 mm prop allows for less glue usage

- Can be used for wall tiling

CLIPS 1 MM BESTSELLER

Product code	Name	Thickness of the clips	Units per bag	Bags per box	Dimensions of the box, cm	Weight of the box, kg	Barcode
LVL22019	Clips	1 mm	100 pcs	20	39.5 x 19.5 x 15.5	2.2	5907572527407

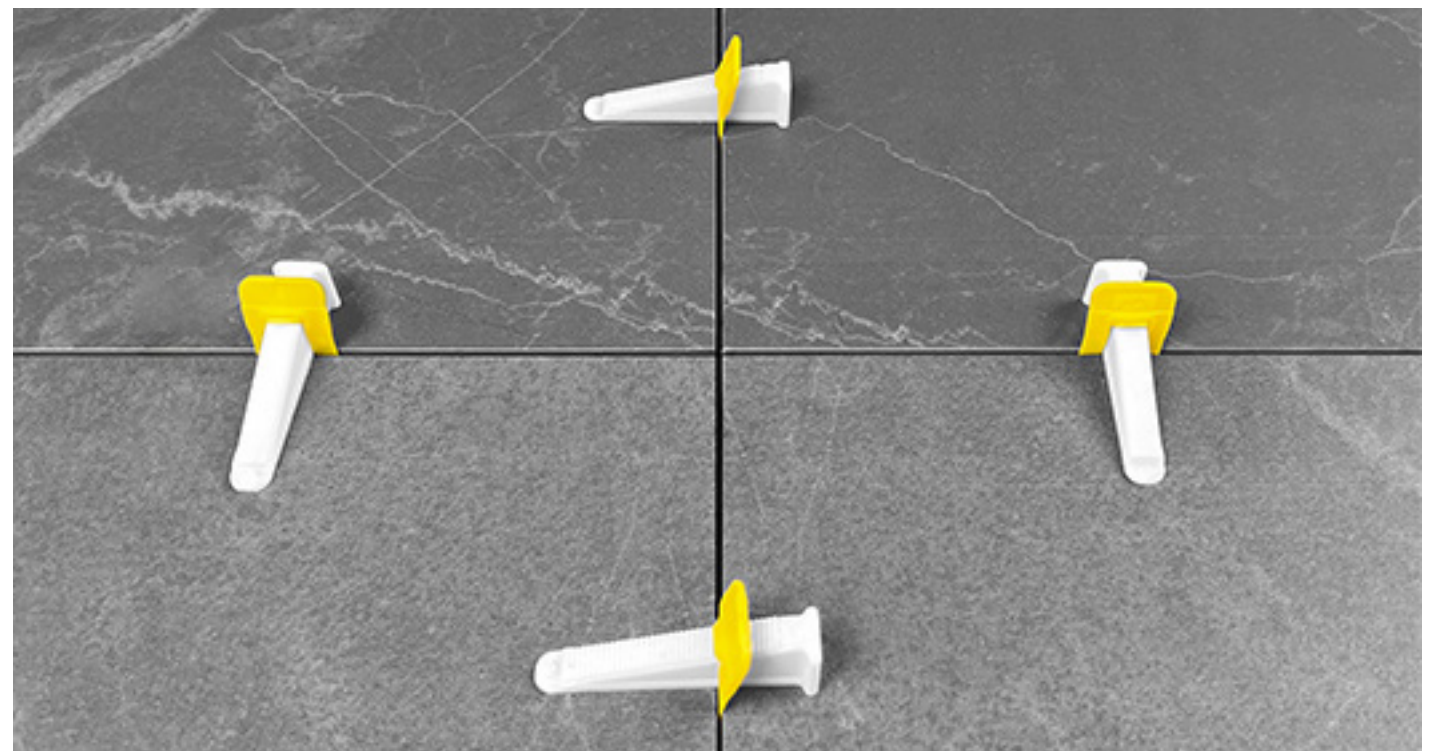
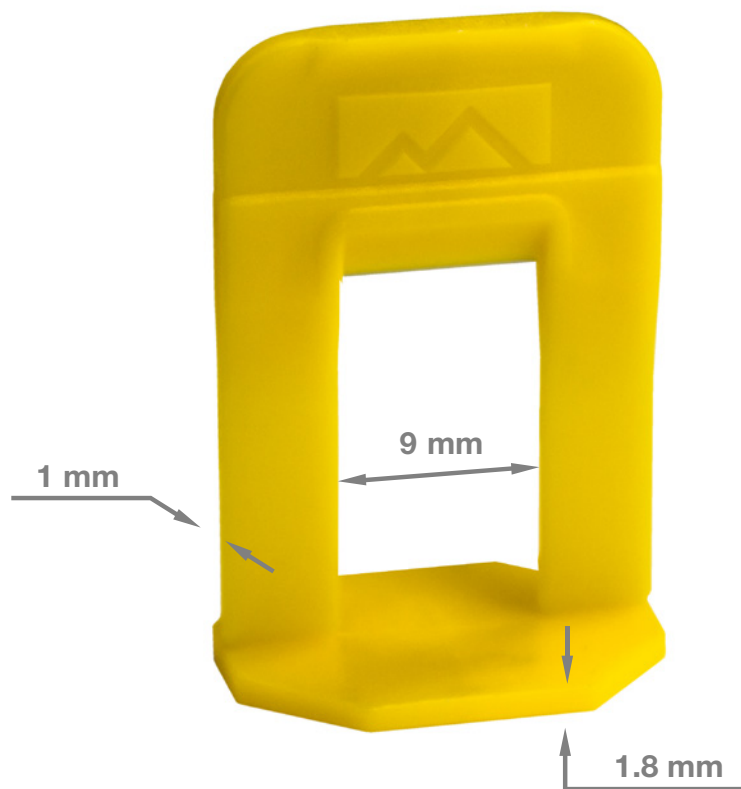

- Do not break during installation and easily break off using a mallet after tiling

- Thin 1.8 mm prop allows for less glue usage

- Can be used for wall tiling

CLIPS 1.4 MM FOR WARM FLOOR

Product code	Name	Thickness of the clips	Units per bag	Bags per box	Dimensions of the box, cm	Weight of the box, kg	Barcode
LVL32019	Clips	1.4 mm	100 pcs	20	39.5 x 19.5 x 15.5	2.2	5907572527414

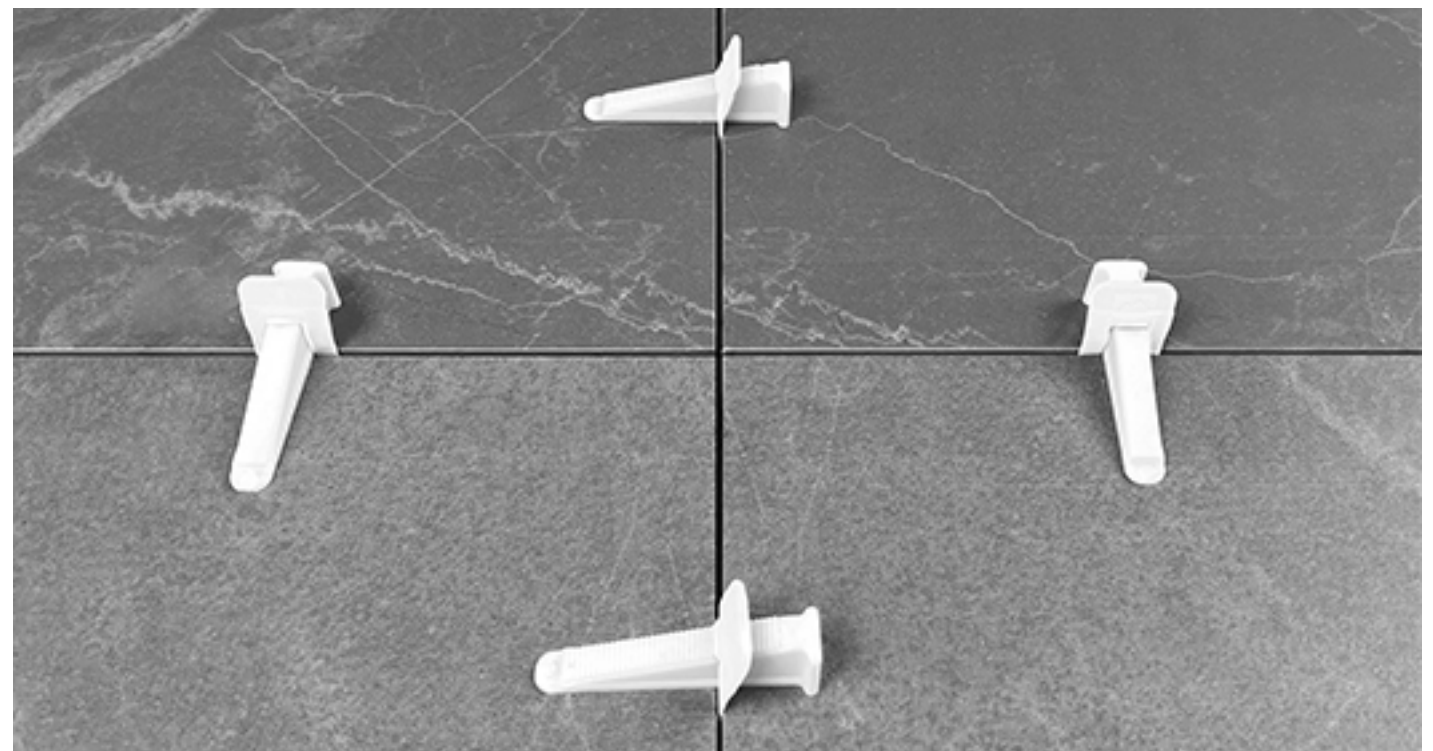
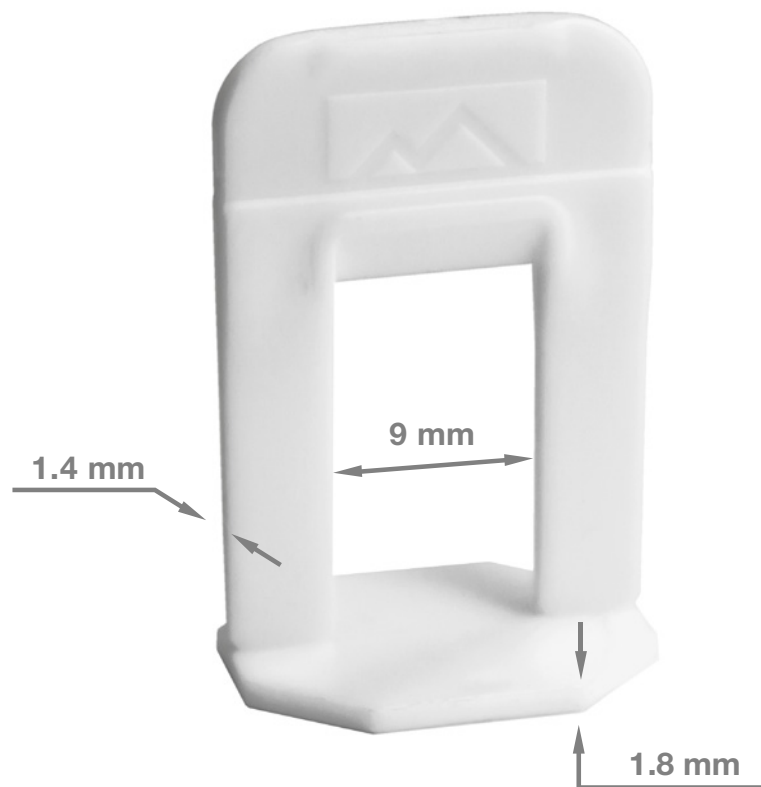

- Do not break during installation and easily break off using a mallet after tiling

- Thin 1.8 mm prop allows for less glue usage

- Can be used for wall tiling

CLIPS 2 MM

STANDART GROUT LINES

Product code	Name	Thickness of the clips	Units per bag	Bags per box	Dimensions of the box, cm	Weight of the box, kg	Barcode
LVL12020	Clips	2 mm	100 pcs	20	39.5 x 19.5 x 15.5	2.3	5903699861295

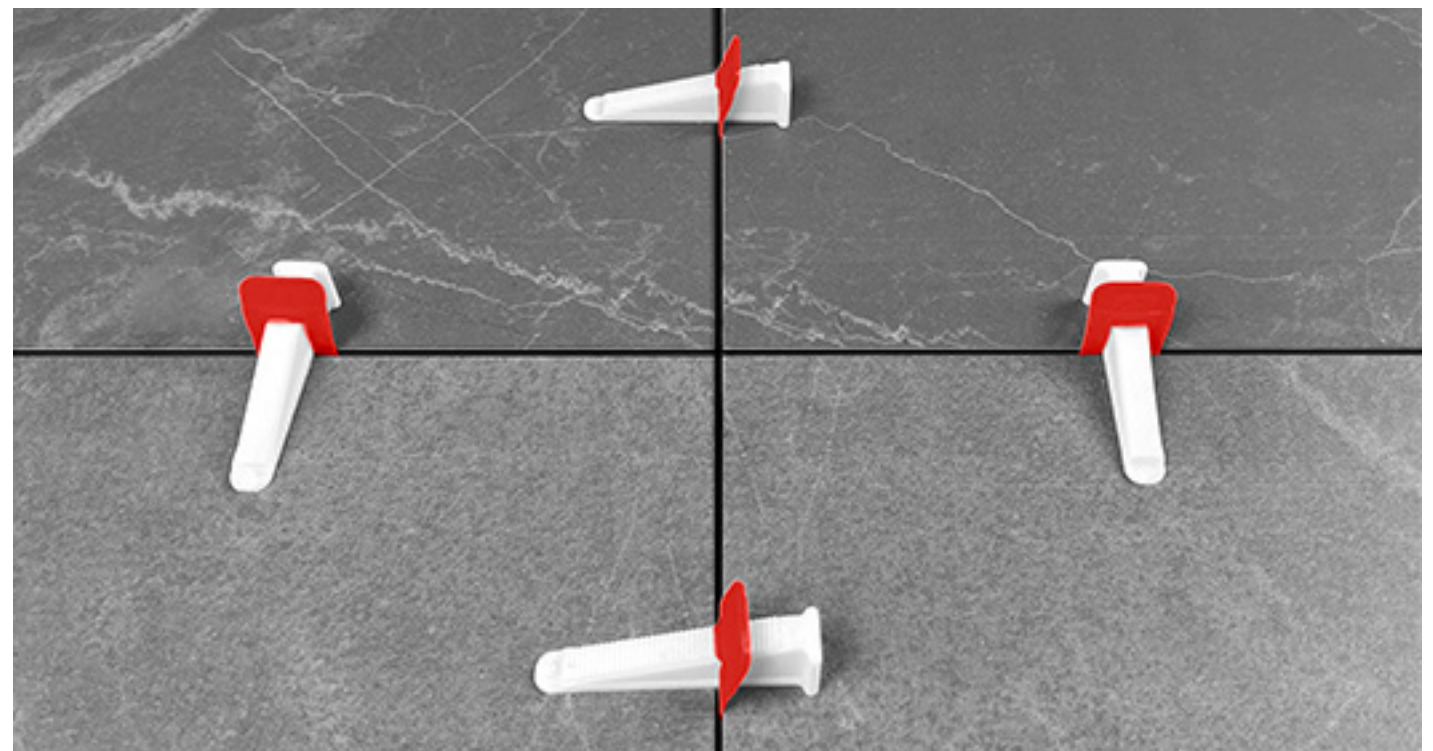
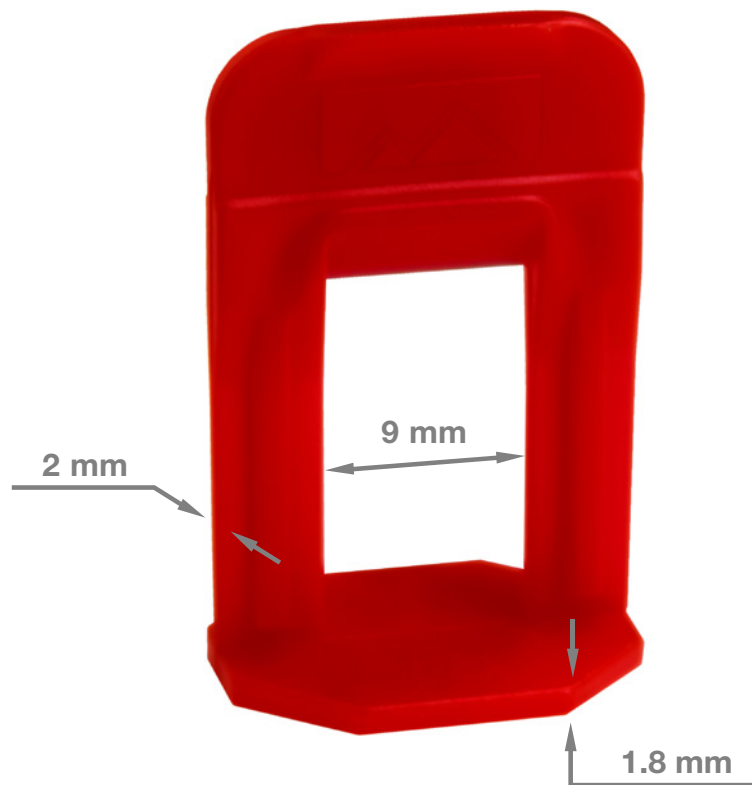

- Do not break during installation and easily break off using a mallet after tiling

- Thin 1.8 mm prop allows for less glue usage

- Can be used for wall tiling

CLIPS 3 MM FOR DECORATIVE GROUT LINES

Product code	Name	Thickness of the clips	Units per bag	Bags per box	Dimensions of the box, cm	Weight of the box, kg	Barcode
LVL42019	Clips	3 mm	100 pcs	20	39.5 x 19.5 x 15.5	2.7	5907572527445

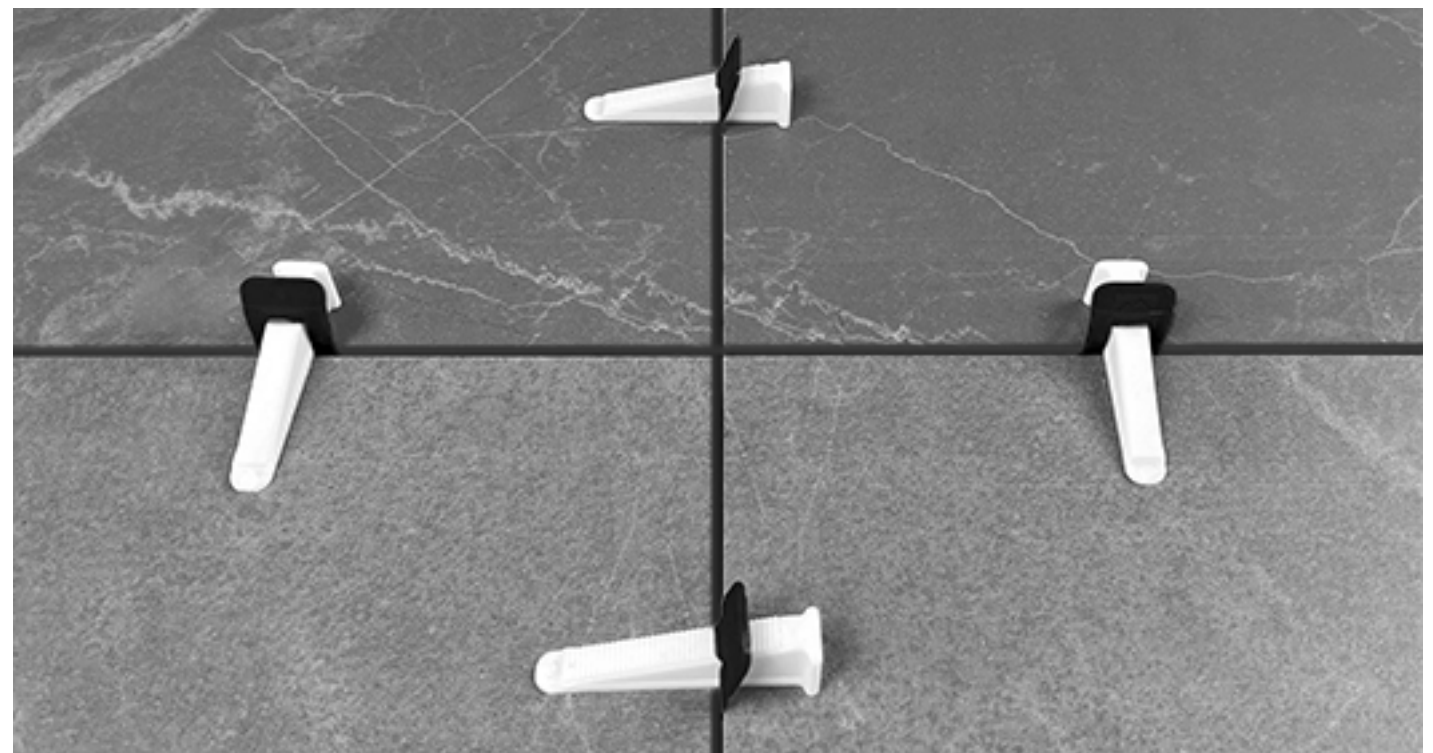
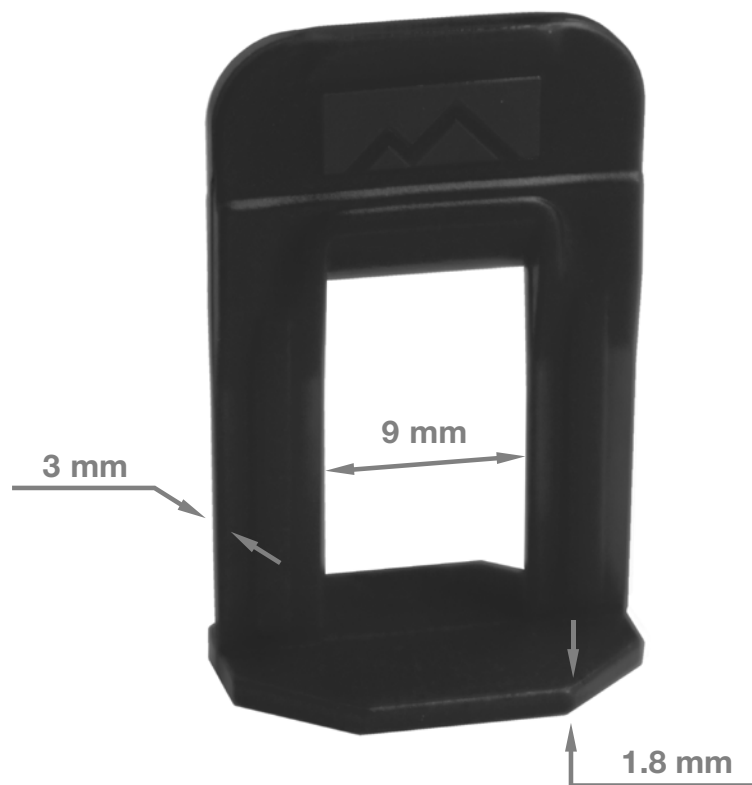

- Do not break during installation and easily break off using a mallet after tiling

- Thin 1.8 mm prop allows for less glue usage

- Can be used for wall tiling

CLIPS 1 MM

FOR GRANITE AND MARBLE (TILE THICKNESS 12 MM - 22 MM)

Product code	Name	Thickness of the clips	Units per bag	Bags per box	Dimensions of the box, cm	Weight of the box, kg	Barcode
LVL12021	Clips	1 mm	100 pcs	20	39.5 x 19.5 x 15.5	2.7	5904035354013

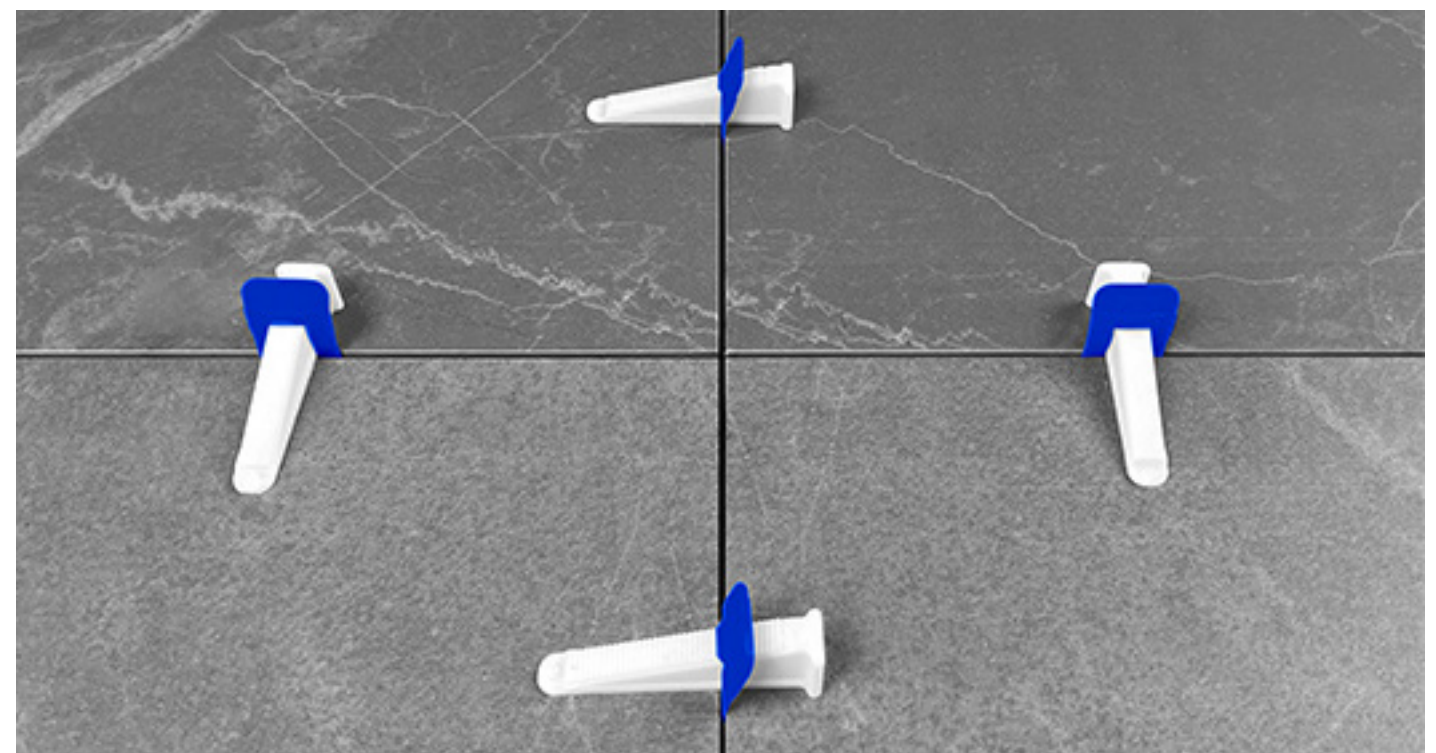
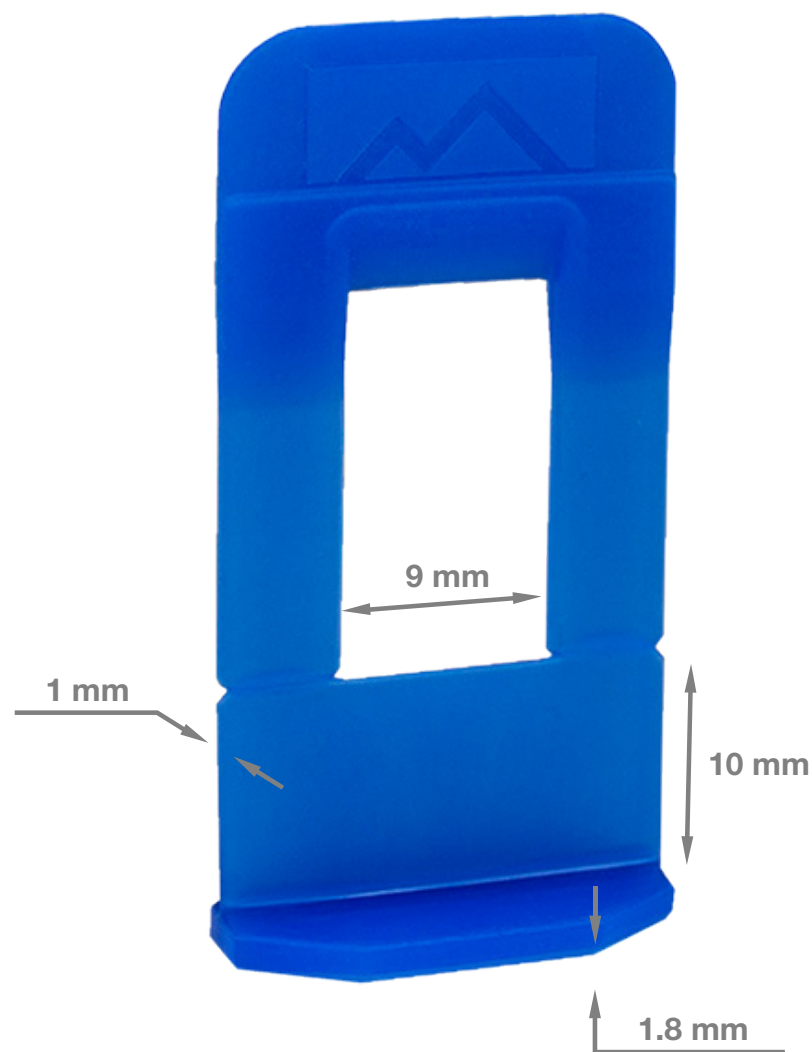

- Do not break during installation and easily break off using a mallet after tiling

- Thin 1.8 mm prop allows for less glue usage

- Can be used for wall tiling

WEDGES

Product code	Name	Units per bag	Bags per box	Dimensions of the box, cm	Weight of the box, kg	Barcode
LVL12019	Wedges	100 pcs	10	39.5 x 19.5 x 15.5	3	5907572527421

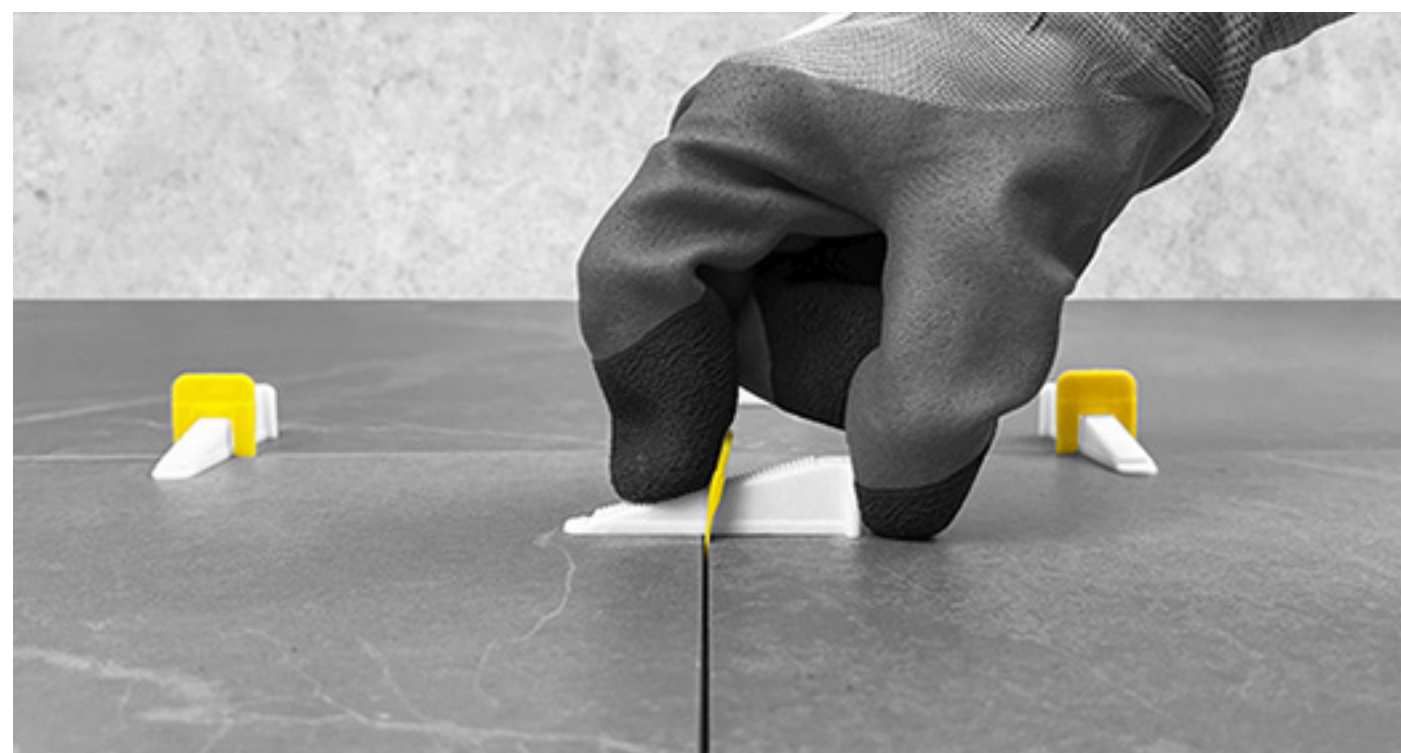
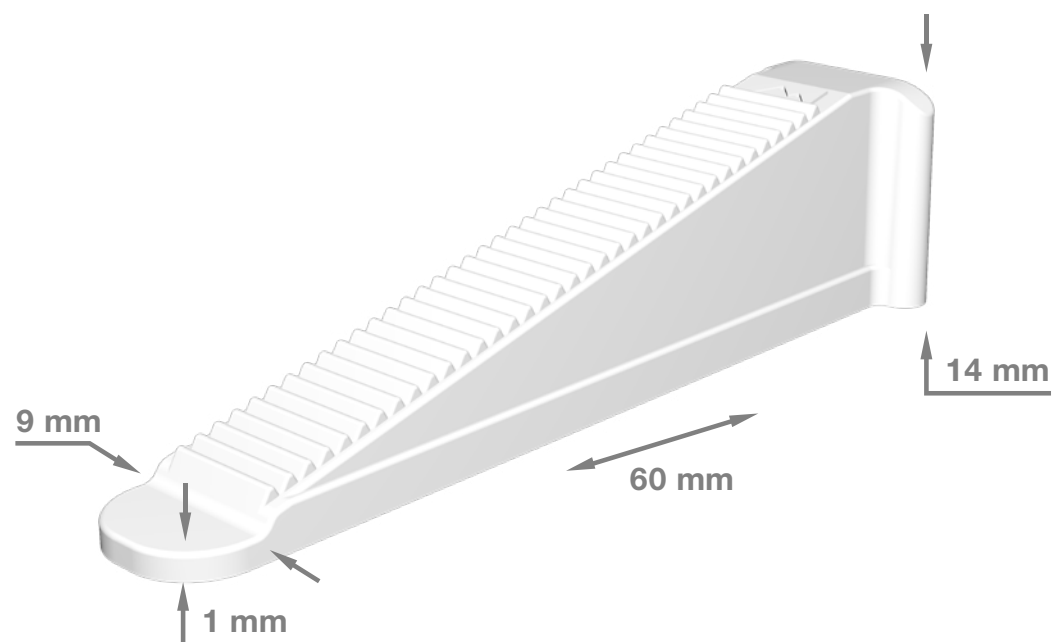

- Do not deform during fixation and installation
- Can be easily tightened without any tools
- Small size allows for convenient usage in corners and other hard to reach places

PLIERS

Product code	Name	Units per bag	Bags per box	Dimensions of the box, cm	Weight of the box, kg	Barcode
LVL52019	Pliers	1 pcs	10 pcs	39.5 x 19.5 x 15.5	2.5	5907572527438

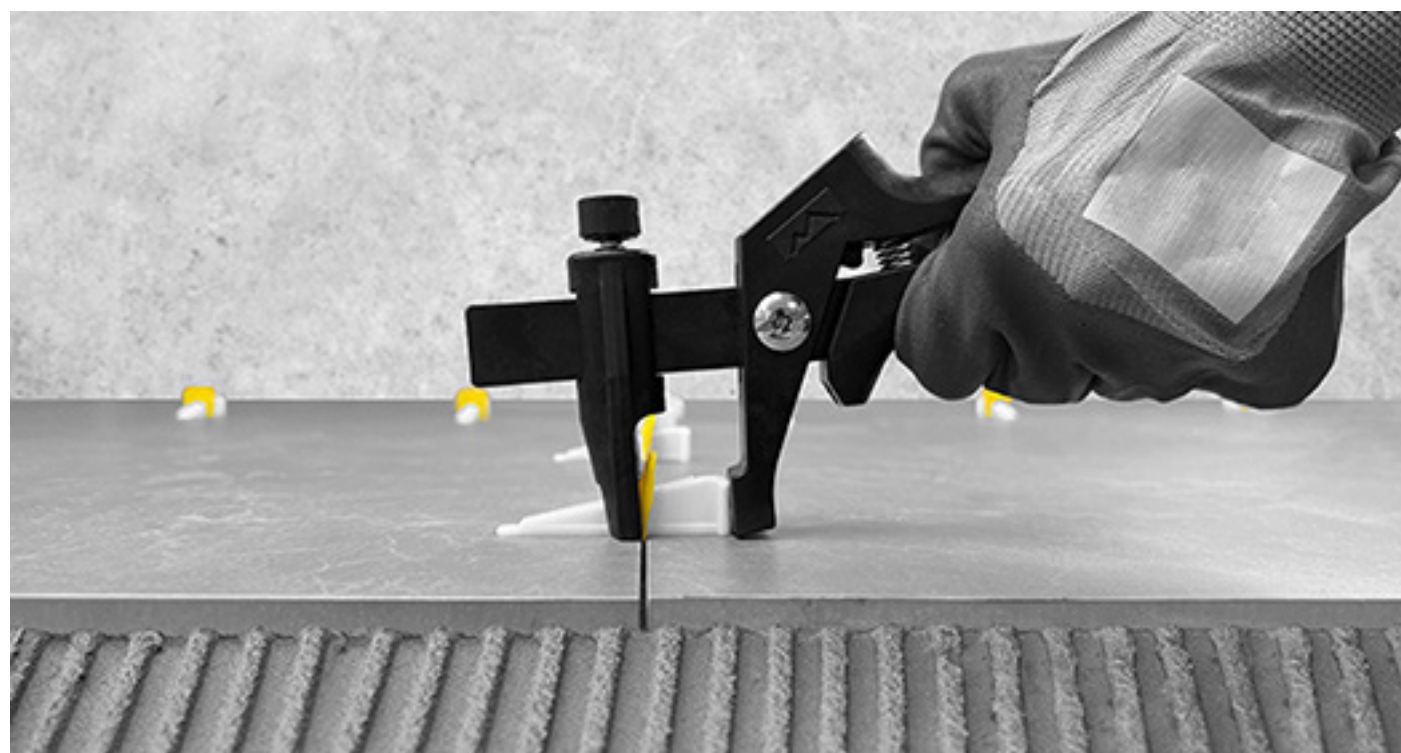

- Make your work more efficient and less time consuming
- Prevents breakdowns thanks to the retainer
- Consistently precise tightening of the wedge
- Convenient for large amounts of tiling

PROTECTION PLATE

Product code	Name	Units per bag	Bags per box	Dimensions of the box, cm	Weight of the box, kg	Barcode
LVLA32020	Protection plate	100 pcs	30	23 x 21 x 18	1.9	5903796787214

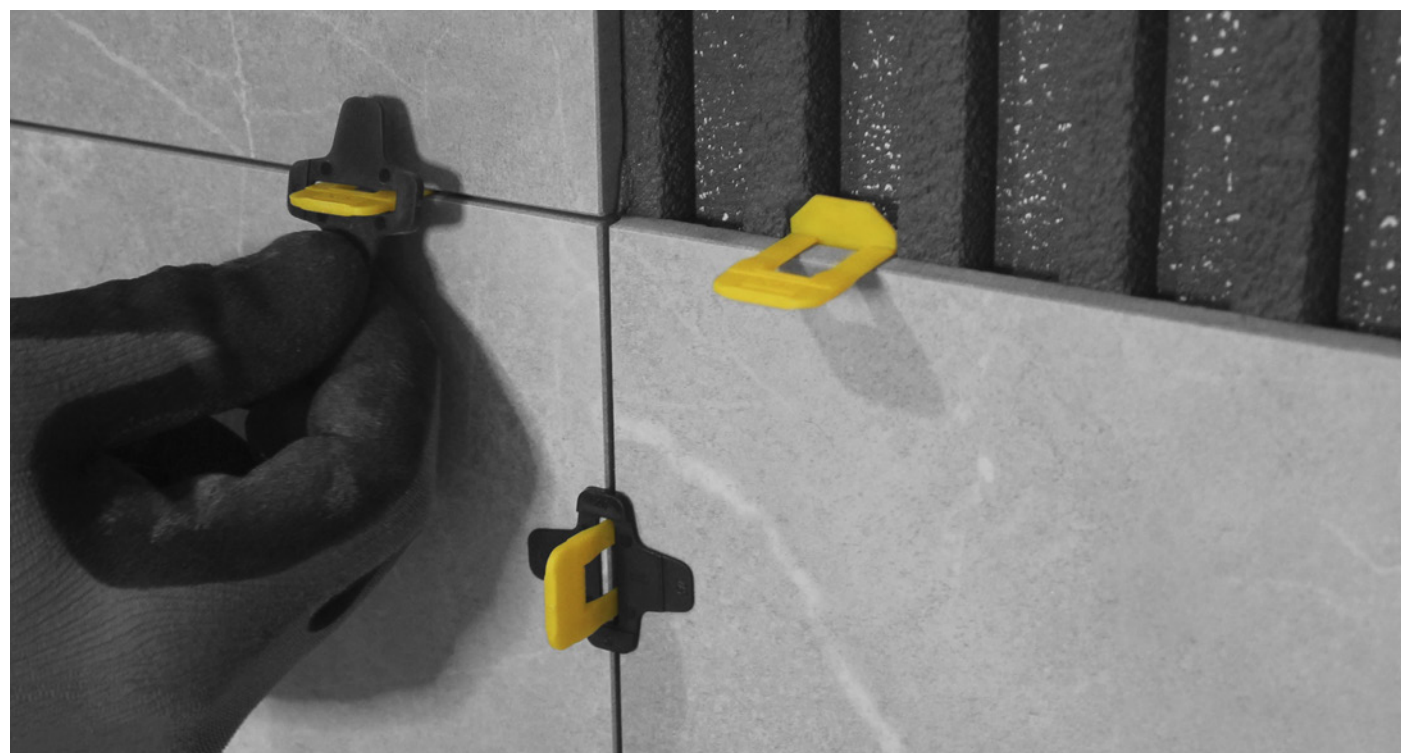

- Designed specifically to protect tiles (fine ceramics and tiles with delicate surfaces)

- Can be used as tile spacers size of 0.5 mm, 1 mm, 1.5 mm, 2 mm

LEVELING BRACKETS

Product code	Name	Units per bag	Bags per box	Dimensions of the box, cm	Weight of the box, kg	Barcode
LVLA42020	Leveling brackets	20 pcs	30	23 x 21 x 18	2.6	5903796787207



- Make the tile installation easier

- More precise on the 90° angles in corners

INSTRUCTION

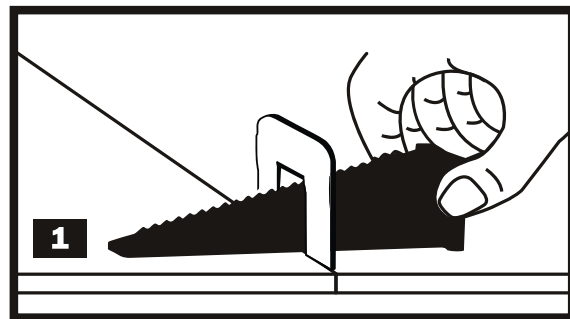

Place 2 clips along every edge of the tile (about 5 cm away from the edge of the tile).
Insert the wedge into the clip and tighten until tiles will be even.

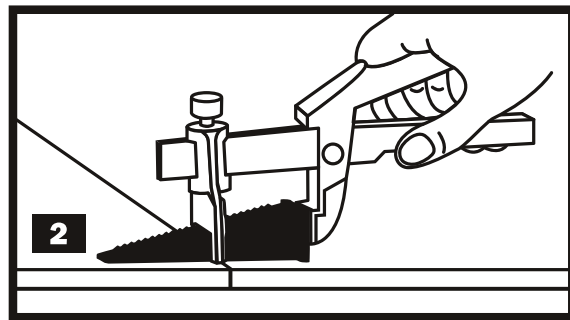

Use UNDERTAG pliers for faster laying.

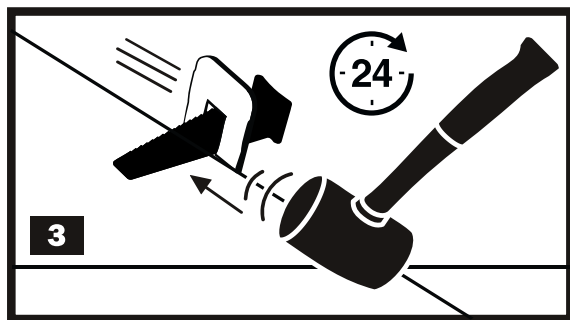

After glue has completely dried (about 24 hours), remove the system by hitting it with a mallet along the grout joint.

CALCULATION OF THE REQUIRED QUANTITY OF CLIPS PER M²*

*the number of pieces may vary depending on the tile layout

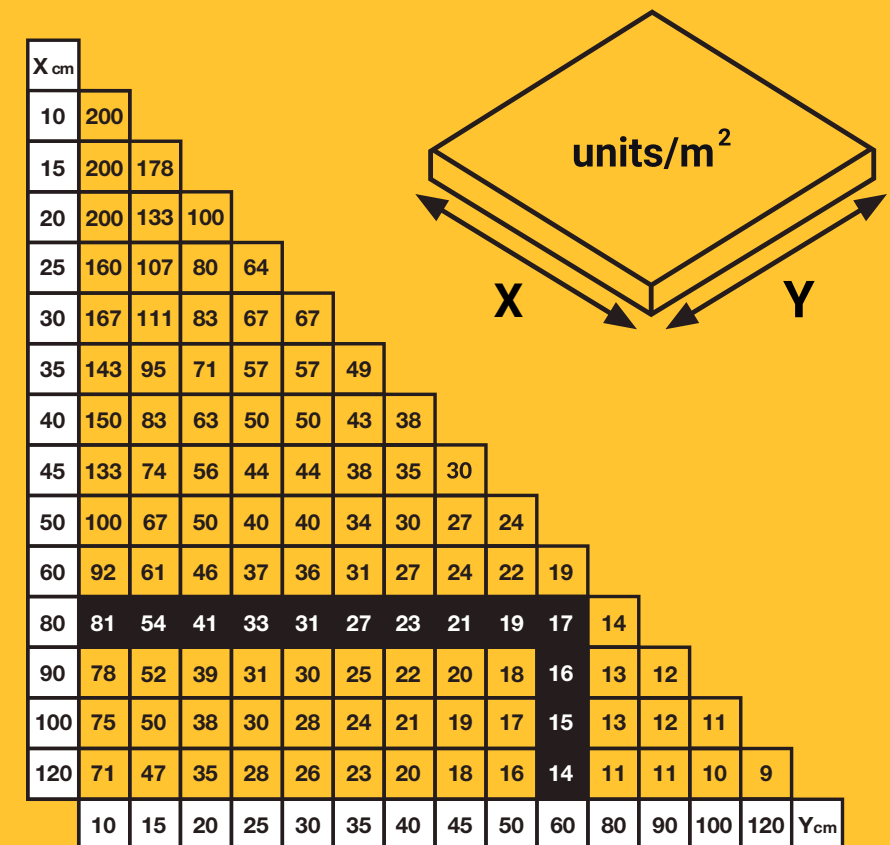

The required number of wedges is about one third of the number of clips. You can also order wedges in the amount that is required for the area that the tiler can lay per day.

X (80 cm) Y (60 cm) = 17 units/m²

WE ARE LOOKING FOR NEW PARTNERS AND POINTS OF SALE

BENEFITS OF WORKING WITH US

- ✓ **SALES GROWTH**
thanks to very high demand
for our products and trade margin
(of 50 percent and more)
- ✓ **PRODUCT RANGE EXPANSION**
and increased choice for customers
- ✓ **INCREASING NUMBER
OF CUSTOMERS**
returning for repeat purchases
- ✓ **REDUCTION OF THE NUMBER
OF RETURNS OF TILES**
thanks to higher quality of laying with our system

More than **250**
companies are
already working
with our system

Manufacturer
price

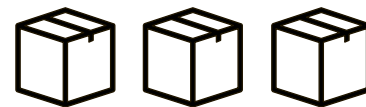

We manufacture
plastic products
for over
20 years

Goods
are always
in stock





CONTACTS

Distributor in Europe

P.P.H.U. TLS Stefan Politanski
82-300 Poland, Elblag
ul. Obroncow Pokoju, 7

☎ +48 604 074 505

✉ sales@undertag.pl

🌐 www.undertag.pl