



PROFESSIONAL TILING TOOLS



Art.No: BPG08



 **BIHUI**
www.bihuitools.com

2024 Catalog



With the key words being innovation and quality, BIHUI develops tools for professional installers and strives to focus on the design, manufacture and distribution of tiling and construction tools for safe handling, transportation and cutting of large format tiles as well as installing all kinds of ceramic & porcelain tiles.

With over 18 years R&D experience and OEM&ODM production, the concept of BIHUI has evolved into a brand that represents the ethos and values. It is based upon offering a comprehensive range of products with a unique recognisable global identity that is visually appealing and informative with a competitive and flexible pricing policy to help build global markets and that is utilising recyclable materials for both product and packing minimising the environmental impact.

MISSION:

Making laying jobs much easier & Making life-living much better

VISION:

To be a Globally Leading Brand in Tiling Tools

VALUE:

Customer First, Innovative, Collaboration, Practical, Proactive





Follow us on our social media
for the latest news



Contact us online www.bihuitools.com or
Send an email to sales@bihuitools.com



Innovation

Quality

High-Performance



XXL2.0



BPTT
Battery Powered Tiling Tools



G-LION



INCISE
Precise cutting for tiles

SELECT



TL



CVT



B-Rolle%



B-RIGID
LEVEL SYSTEM



SWITCH
SYSTEM



DOA
Diamond Order Arrangement



TD
DELUXE

SPIN

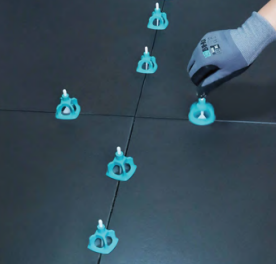

EP



T



ETS
2cm tile solution





PROFESSIONAL TILE TOOLS

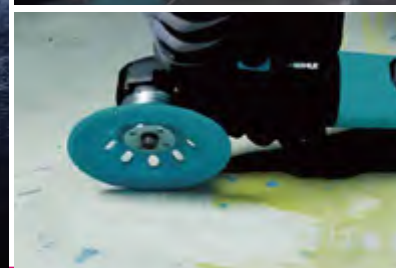
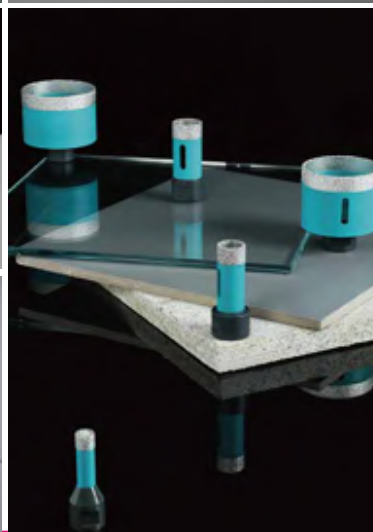

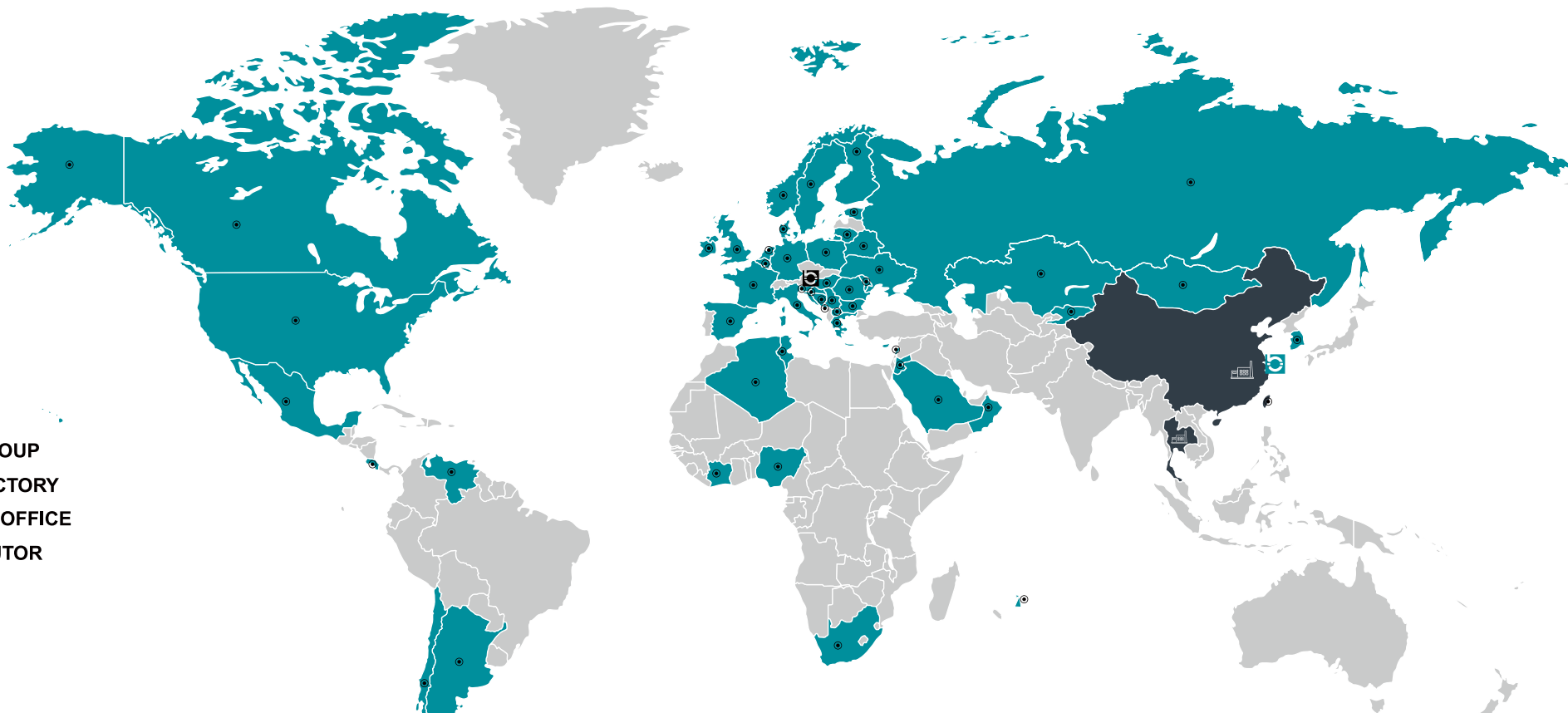

- BIHUI GROUP
- BIHUI FACTORY
- BRANCH OFFICE
- DISTRIBUTOR

* Base on Wikipedia

Eastern Europe

- Russia
- Belarus
- Ukraine
- Estonia
- Lithuania
- Moldova
- Hungary
- Poland
- Romania
- Bulgaria

Southern Europe

- Italy
- Spain
- Greece
- Cyprus
- Croatia
- Serbia
- Bosnia And Herzegovina
- Slovenia
- Kosovo
- Montenegro
- Macedonia

Northern Europe

- Sweden
- Norway
- Denmark
- Finland

Western Europe

- United Kingdom
- Ireland
- Belgium
- Netherlands
- Germany
- France

South America

- Costa Rica
- Chile
- Argentina
- Venezuela
- Mauritius

North America

- U.S.A
- Canada
- Mexico

Africa

- Nigeria
- South Africa
- Algeria
- Tunisia
- Côte d'Ivoire

Asia

- Israel
- South Korea
- Sultanate of Oman
- Taiwan
- Kazakhstan
- Saudi Arabia
- Mongolia
- Jordan
- Tajikistan

JOIN US . . .

BECOME THE TILING TOOLS LEADER IN YOUR MARKET

DISTRIBUTORS 60+
BIHUI TEAM 150+
PRODUCTION BASE 2
OFFICE 2

PRODUCT CATALOG

16	LARGE FORMAT TOOLS	16-31	98	TILE SPIRIT LEVEL	98-99
32	TILE CUTTER & TILE SAW	32-44	100	TILE BEATER & SUCTION CUP	100-109
45	DIAMOND TOOLS	45-75	110	LEVELING SYSTEM & TILE SPACERS	110-118
76	CONCRETE GRINDER	76-78	119	NOTCHED & BRICKLAYING TROWEL	119-125
79	VACUUM CLEANER	79-83	126	CLEANING TOOLS	126-130
84	ELECTRIC MACHINE	84-87	131	TILING TOOLS	131-137
88	MIXING MACHINE & PADDLE	88-91	138	PROMOTIONAL ITEMS	138-141
92	ALUMINUM BOX SCREED SET	92-93	142	TRADE FAIRS & MERCHANDISING	142-149
94	LASER LEVEL	94-97	150	BLADE GUIDELINE	150-153
			154	ICONS AND CERTIFICATIONS	154-155

TILE INSTALLATION 5 STEPS

PREPARATION

1

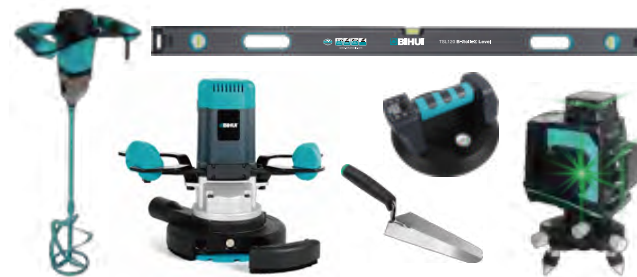

CUTTING & DRILLING

2



INSTALLATION

3



GROUTING

4



CLEANING

5





Trade Electric Cutting System

- ▲ Compatible rails with the trade manual cutting system. **Two systems, One rail**
- ▲ Reinforced rails with steel rod, make cutting more stable, precise and longer lifetime
- ▲ Suitable for cutting tiles and slabs sizes up to 3.2m long
- ▲ CE approved electric cutting machine, 1,500W, 230V/50Hz, 13,000RPM
- ▲ Featured with 90degree and 45degree cutting
- ▲ Max. Straight Cutting depth 17mm
- ▲ Max. Angle Cutting depth 15mm

Components:

- 1 x Premium cutting blade 125mm
- 1 x Edge cutting blade 125mm
- 4 x Plastic suction cup
- 2 x F clamp for fixing the rail
- 1 x Rubber adaptor
- 1 x small tools bag with fixing accessories

Art.No			
LFEC5	320cm(126")	3-15mm(1/8"- 19/32")	1
LFRS5	320cm(126")	3-15mm(1/8"- 19/32")	1



PATENTED

XXL2.0



Trade Manual Cutting System

- ▲ Compatible rails with trade electric cutting system. **Two systems, One rail**
- ▲ Reinforced rails with steel rod, make cutting more stable, precise and longer lifetime
- ▲ Suitable for cutting tiles and slabs sizes up to 3.2m long
- ▲ Revolutionary cutter head can cut tiles up to 15mm thick
- ▲ Heavy duty breaker with higher breaking force for 3-15mm thick tiles

Components:

- 3 x aluminium rails
- 4 x plastic suction cup
- 1 x cutting head
- 1 x breaker nipper
- 1 x spare wheel in plastic box
- 1 x small tools bag with fixing accessories

Art.No			
LPMC5	320cm(126")	3-15mm(1/8"- 19/32")	1
LFRS5	320cm(126")	3-15mm(1/8"- 19/32")	1

PATENTED



Breaker Nippers

Art.No	Breaking
LFTBE	Max.8mm(5/16") thick
LFTBD	Max.15mm(19/32") thick
LFTBH	Max.15mm(19/32") thick



MANUAL CUTTING SYSTEM

XXL





Manual Cutting System

- ▲ Compatible rails with the electric cutting system. **Two systems, One rail**
- ▲ Suitable for cutting tiles size upto 3,2M
- ▲ Rails in size 1,4M and 0,8M for different tile length
- ▲ Cutting depth 6-8mm

PATENTED

Components:

- 1 x Carbide wheel assembled
- 1 x Spare wheel in box
- 4 x Plastic suction cup
- 2 x F clamp
- 1 x Breaking clamp
- 1 x Breaking nipper

Art.No			
LFMC	320cm(126")	6-8mm(1/4"- 5/16")	1
LFRS	320cm(126")	6-8mm(1/4"- 5/16")	1



ELECTRIC CUTTING SYSTEM

XXL



CE



PATENTED

Electric Cutting System

- ▲ Compatible rails with the manual cutting system. **Two systems, One rail**
- ▲ CE approved electric cutting machine, 1,500W, 230V/50Hz, 13,000RPM
- ▲ Suitable for cutting tiles size upto 3.2M
- ▲ Featured with 90degree and 45degree cutting
- ▲ Dry cutting with dust extractor hood and adaptor to the vacuum machine
- ▲ Max. Cutting depth 17mm
- ▲ Packed in plastic case and storage tool bag

Components:

- 1 x Premium cutting blade 125mm
- 1 x Edge cutting blade 125mm
- 4 x Plastic suction cup
- 2 x F clamp for fixing the rail
- 1 x Rubber adaptor

Art.No			
LFEC	320cm(126")	6-17mm(1/4"- 85/127")	1
LFRS	320cm(126")	6-17mm(1/4"- 85/127")	1



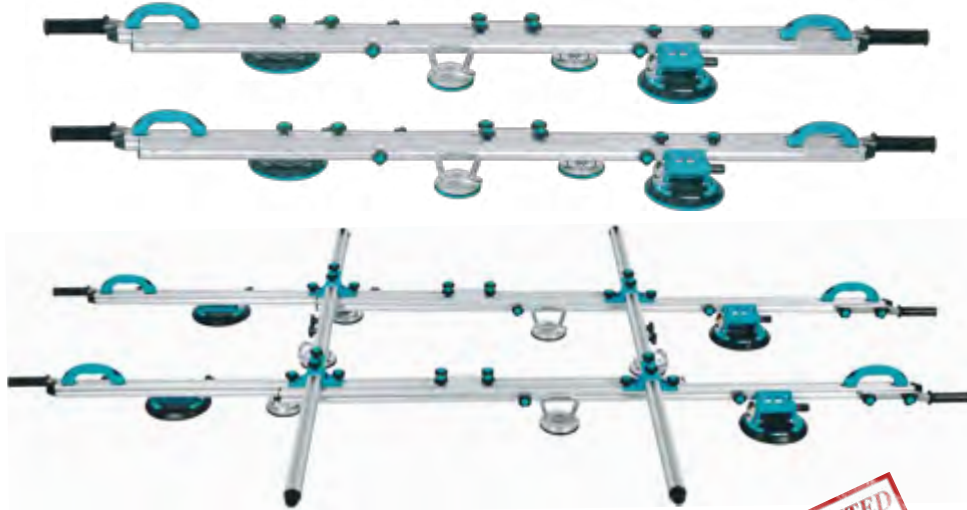

Classic Carrier System

- ▲ Max. Capacity: 3.2x1.6M
- ▲ Max. Lifting Capacity: **130kg (286 lbs)**
- ▲ 2pcs longitudinal rails with soft grip handles
- ▲ Adjustable length: 1700-3200mm
- ▲ Includes 4 vacuum suction cup and 6 aluminum suction cup
- ▲ Robust and stable plate for large-format plates

PATENTED

Art.No	Size
LFCSV4	3.2x1.6M(126"x63")



Trade Carrier System

- ▲ Max. Capacity: 3.2x1.6M
- ▲ Max. Lifting Capacity: **200Kg (441 lbs)**
- ▲ Includes 6 or 8 vacuum suction cup with brass handle
- ▲ Featured with four soft grip handle on the top and four extension handle on the side for extra force
- ▲ Lightweight and easy to transport large format tiles thanks to the adjustable extension bar so to adapt to tiles sizes to handle them

PATENTED

Art.No	Size
LFCSV6	6xSCVG8

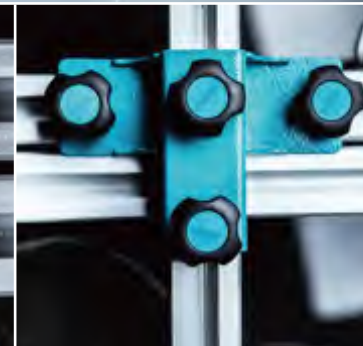



Battery Powered Master Carrier System

- ▲ Max. Capacity: 3.2M x 1.6M
- ▲ Max. Lifting Capacity: **200Kg (441 lbs)**
- ▲ Includes 6pcs battery powered vacuum suction cup with digital panel
- ▲ Interchangeable design for switching the suction cup
- ▲ Featured with four soft grip handle on the top and four extension handle on the side for extra force
- ▲ Lightweight and easy to transport large format tiles thanks to the adjustable extension bar so to adapt to tiles sizes
- ▲ Suitable for both smooth and texture tiles

XXL2.0

Art.No	Size
LFCSB-2R	1.9M(75")
LFCSB-2F	1.65M(65")
LFCSB-6C	200mm(8")
LFCS-BAG	/



Folding Work Stand Table

- ▲ Seconds to set up and fold up
- ▲ Easy storage and transport
- ▲ Aluminium alloy legs, soft grip ends zero scratch the ground surface
- ▲ Multiple support points, very stable without shaking on uneven ground
- ▲ Set up as a large portable workbench at any job site

Art.No	Opening Dimension	Folded Dimension	Loading Capacity
LFFT	221x113x73cm	87"x44"x73"	32.5x19.5x88.5cm 12.8"x7.7"x34.8" 300Kg(660lbs)



Tilers Multi-function Workbench

- ▲ Reinforced portable workbench with ergonomic working height
- ▲ Extendable tile supports for increased work surface upto 720mm
- ▲ Longitudinal groove for 45° & 90° cutting and 110mm holes with drill guide for drilling
- ▲ Easy to put the manual tile cutter on it and can be used as a small scaffold
- ▲ Designed with four folding legs, carrying handles and wheels for easy transport
- ▲ Comes complete with two F clamps, adjustable rulers and restraints
- ▲ Table size 1160mm and straight cutting size 950mm

Art.No	Size	Loading Capacity
TWT900	116cm(46")	200Kg(441lbs)



Tiler's Working Bench Master

- ▲ All in one design with foldable legs and transport wheels
- ▲ With carry handle and height adjustment to the floor
- ▲ Work as a table or trolley for fixing problems to the wall or to the car etc.
- ▲ Suitable for cutting, drilling, polishing jobs as well as transportation
- ▲ Adjustable height in 560mm, 613mm, 665mm, 717mm and 770mm

Art.No	Open Size	Table size	Accessory Table Size
TWTMST	1070x440x760mm	800 x 400	180x400mm

NEW



CE

M14



ETL
LISTED
US

5/8"-11

Mitre Jolly Cutting System

- ▲ Includes cutting frame and BIHUI angle grinder
- ▲ Made of stainless steel with cushion stripe
- ▲ Cutting angle range 45-48°
- ▲ Max. cutting length unlimited
- ▲ Max. cutting thickness 19mm
- ▲ Diamond blade 125mm
- ▲ Product weight: 5.2 Kg
- ▲ Dust collector for 32mm hood
- ▲ Suitable for M14 and 5/8"-11 angle grinder

Art.No	Size
LFMBF	270x146x190mm 10-1/4"x6"x7-1/2"
LFMBA	270x146x190mm 10-1/4"x6"x7-1/2"





Working Bench

- ▲ A lightweight, robust and stable workbench for large-format tiles, enabling cutting / drilling without risk of damaging the work surface
- ▲ Easily assembled for transport and storage and can be mounted together with additional tables for increased work surfaces
- ▲ Foldable legs and storage hooks for cutting system
- ▲ Height: 800mm
- ▲ Width: 1400mm
- ▲ Length: 1800mm
- ▲ Max. Load: **200kg(441 lbs)**
- ▲ Suitable for tile size upto 3.6 x 1.4M after 2 tables joint together

Art.No	Size
LFWB	1.8x1.4M(71"x55")



PATENTED

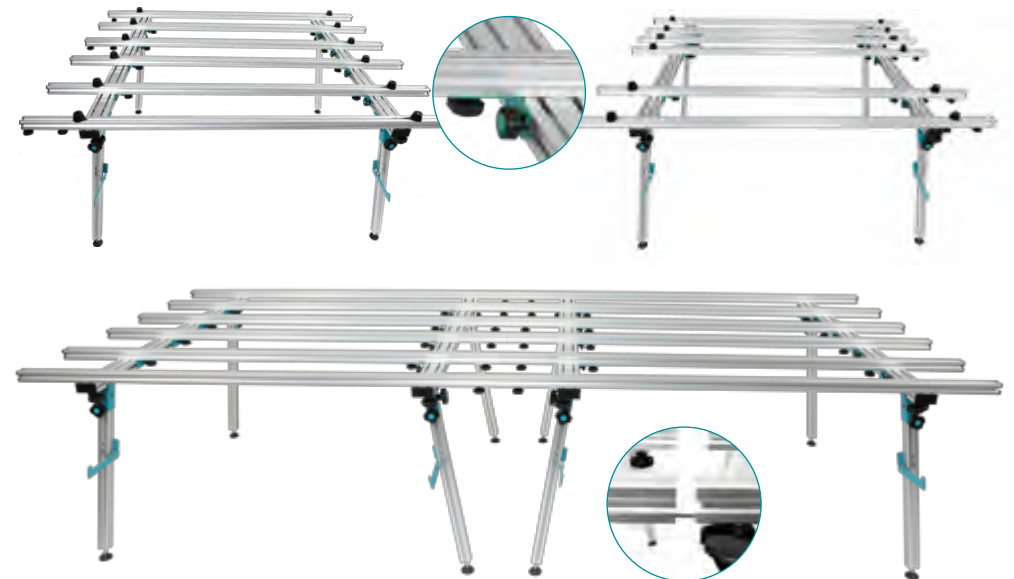



Transport Cart

- ▲ The ideal solution to move large format slabs of porcelain stoneware in the warehouse, places of installation offering a work area to apply the adhesive
- ▲ Thanks to the four rubber castors (lockable) positioned on each corner, superb control of movement and direction is created plus they make it extremely stable
- ▲ Max. Load: **280kg(617 lbs)**
- ▲ Suitable to display tile size upto 3.2 x 1.6M

Art.No	Size
LFCART	3.2x1.6M(126"x63")



Tile Beater

- ▲ Eliminate air from underneath the tile
- ▲ Heavy duty rubber pad

Art.No	Size
BLFTBT	355x148x10mm (14"x6"x3/8")



Tile Space & Level Regulator

- ▲ Ideal for adjust tile gap in horizon from 0.5mm to 40mm
- ▲ Two buttons for adjusting tile level
- ▲ With 2pcs 6 inch vacuum suction cup
- ▲ Light duty and durable structure
- ▲ Ideal for large porcelain or stone tiles and glass

Art.No	Size
LFTSB6	0.5-40mm(1/64")-(1-5/8")



PREMIUM Tile Space & Level Regulator

- ▲ Designed to shortening gaps between tiles
- ▲ Adjustable from 0.5-40mm
- ▲ Two buttons for adjusting tile level
- ▲ Ideal for handling with porcelain or stone tiles and glass
- ▲ With 2pcs 6 inch vacuum suction pad

Art.No	Size
LFTSR2	0.5-40mm(1/64")-(1-5/8")

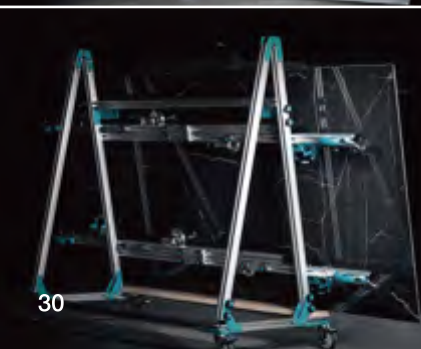

Multi Angle Tile Fixer & Adjuster

- ▲ With vacuum suction cup
- ▲ Work for 90° & 180° & 270° alignment and tile gap adjustment
- ▲ Two buttons for adjusting tile level
- ▲ Light duty and durable structure
- ▲ Ideal for handling with porcelain or stone tiles and glass

Art.No	Size
LFTFV6	Universal





C-Lion Tile Cutter

- ▲ Double-layer aluminum alloy chassis, strong and durable
- ▲ Tungsten carbide scoring wheel with etched scale for using with different tile thickness
- ▲ Anti-rotation handle for change scoring wheels from Ø1/4" (6mm) to Ø7/8"(22mm)
- ▲ Ø7/8"(22mm) scoring wheel included
- ▲ Magnetic absorption and fast release breaking device with 800kg breaking power for single-handed operation
- ▲ Adjustable measurement guide and side ruler for cutting tiles from different angle
- ▲ Anti-slip handle with storage function and snap-in for locking the handle
- ▲ LED light for extra vision and laser level for precise cutting(600mm version not included)
- ▲ 1M and 1.2M tile cutter with caster design
- ▲ Suitable for cutting all kinds of ceramic tiles, such as wall tiles, polished tiles and glazed tiles

Art.No	Cutting Length		Diagonal Cutting Length(mm)	Cutting Thickness (mm)	Breaking force (kg)
TCB600	600	24"	424 x 424	3 - 18	800
TCB800	800	31-1/2"	560 x 560	3 - 18	800
TCB1000	1000	40"	700 x 700	3 - 18	800
TCB1200	1200	47-1/4"	850 x 850	3 - 18	800

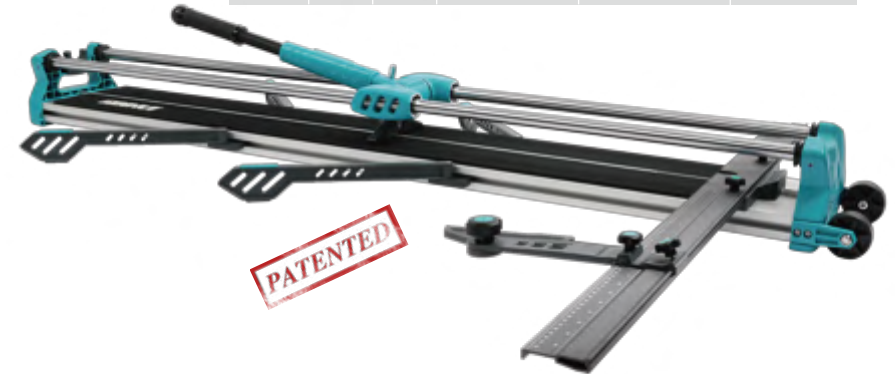

1.Magnetic absorption breaking device



2.Quick change a wheel



3.Snap-in for locking the handle



4.Adjustable measurement guide and side ruler



5.Patent laser line & LED light (600mm version not included)



6.Anti-slip handle with storage function

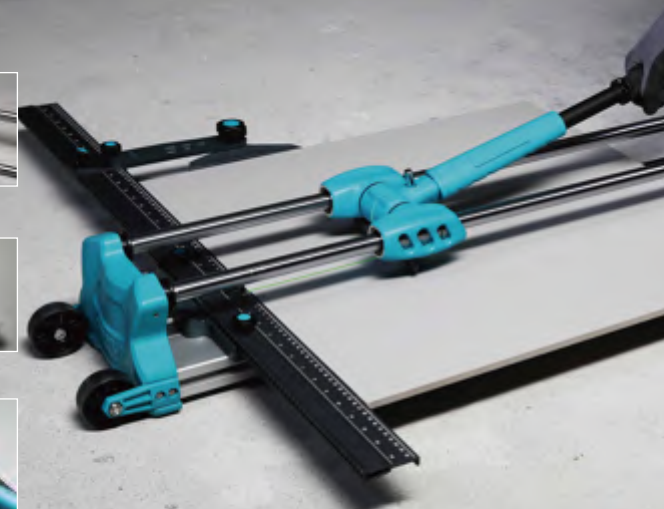

INCISE Tile Cutter

- ▲ One-piece aluminum alloy die casting forming base
- ▲ Single rail system, simple and durable
- ▲ Integral molding design for breaking part, cutting head and handle
- ▲ Smart and easy adjusting knob for fitting with different thickness tiles
- ▲ Suitable for cutting with 90° or any angles.
- ▲ Visible cutting angle and scale plate in white and black
- ▲ Readable ruler with double row scale and pointing arrow
- ▲ Angle positioning with limitation design for easy and precise location
- ▲ Storable inclined bracing for extra support



COMING SOON
COMING SOON

Art.No	Cutting Length		Diagonal Cutting Length(mm)	Cutting Thickness (mm)	Breaking force (kg)
TCA400	400	15-3/4"	280x280	5 - 18	600
TCA750	750	29-1/2"	530 x 530	5 - 18	1000
TCA930	930	36-1/2"	660 x 660	5 - 18	1000
TCA1250	1250	49"	880 x 880	5 - 18	1000

Deluxe Tile Cutter

- ▲ Aluminum die casting one-piece base, strong and durable
- ▲ Special designed single guide rail with built-in bearing system
- ▲ Magnetic absorption and fast release breaking device
- ▲ Extension bars to support large tile cutting
- ▲ Suitable for cutting with 90° or any angles
- ▲ Visible swing position ruler in metric and inch
- ▲ Tungsten carbide scoring wheel 22mm
- ▲ Laser line for precise cutting
- ▲ With two casters and carry handle
- ▲ Suitable for cutting all kinds of ceramic tiles, such as wall tiles, polished tiles and glazed tiles

Art.No	Cutting Length		Diagonal Cutting Length(mm)	Cutting Thickness (mm)	Breaking force (kg)
TCD080	800	31-1/2"	560 x 560	5 - 18	1000
TCD120	1200	47-1/4"	840 x 840	5 - 18	1000
TCD160	1600	63"	1130 x 1130	5 - 18	1000



1.Ball bearing cutting system 2.LED working light



3.Elastic support plate 4.Inclined bracing



5.Angle positioning 6.Thickness adjuster

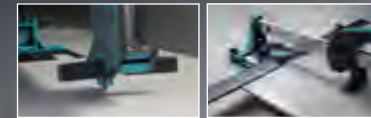
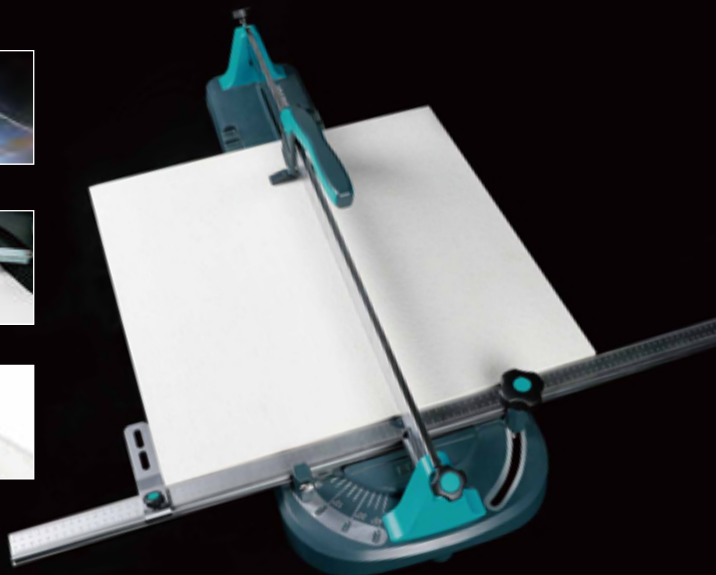

1.Ball bearing cutting system 2.Laser line



3.Swiveling guide 4.Inclined bracing



5.Transport wheel 6.Carry handle





Wise Power Tile Cutter

- ▲ Aluminum die casting one-piece base, strong and durable
- ▲ Special designed single guide rail with built-in bearing system
- ▲ Magnetic absorption and fast release breaking device
- ▲ Extension bars to support large tile cutting
- ▲ Suitable for cutting with 90° or any angles
- ▲ Visible swing position ruler in metric and inch
- ▲ Tungsten carbide scoring wheel 22mm
- ▲ Laser line for precise cutting
- ▲ With two casters and carry handle
- ▲ Suitable for cutting all kinds of ceramic tiles, such as wall tiles, polished tiles and glazed tiles

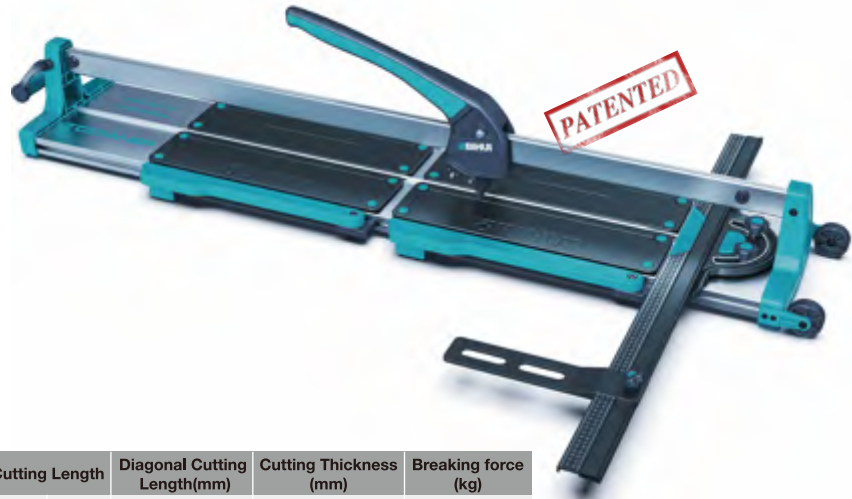

Art.No	Cutting Length	Diagonal Cutting Length(mm)	Cutting Thickness (mm)	Breaking force (kg)
TCW080	800 31-1/2"	560 x 560	6 - 20	1200
TCW120	1200 47-1/4"	840 x 840	6 - 20	1200
TCW160	1600 36-1/2"	63"	6 - 20	1200

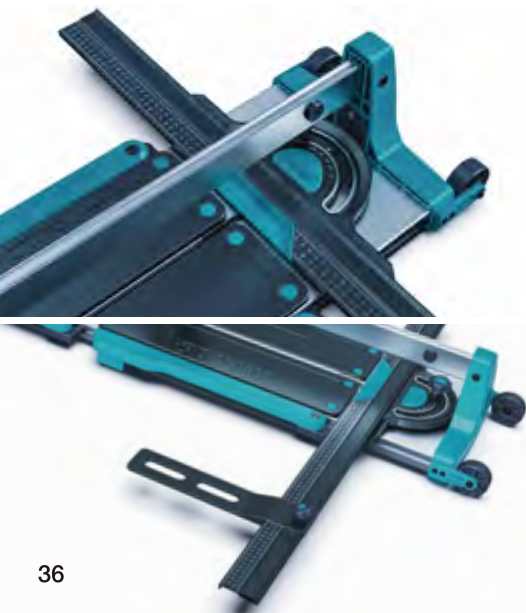

Strong Tile Cutter

- ▲ Thick double layer aluminum alloy base
- ▲ Solid single rail system
- ▲ Long lifetime scoring wheel Ø22x5x5mm
- ▲ Magnetic absorption breaking device
- ▲ Extension legs with 45° guide for large tiles
- ▲ Laser line for precision cutting
- ▲ With two castors and carry handle

Art.No	Cutting Length	Diagonal Cutting Length(mm)	Cutting Thickness (mm)	Breaking force (kg)
TCP1200	1200 47-1/4"	840 x 840	5 - 20	1000
TCP1600	1600 63"	1130 x 1130	5 - 20	1000



1.Laser line for extra precision



2.Strong rail frame



3.Magnetic absorption breaking device



4.Mitre cutting 45°

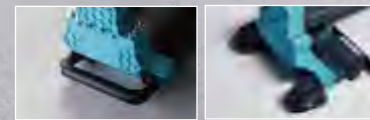

5.Carry handle



6.Transport wheel



TILE CUTTER

Laser Tile Cutter

- ▲ Thick 1.6mm double layer aluminum alloy base
- ▲ Solid rail system 20x40mm
- ▲ Long lifetime scoring wheel Ø22x5x5mm
- ▲ Magnetic absorption breaking device
- ▲ Adjustable cutting frame
- ▲ Extension bars for 1M/1.5M mitre cutting
- ▲ Guide for mitre cutting 45°
- ▲ Laser line for extra precision

Art.No	Cutting Length	Diagonal Cutting Length(mm)	Cutting Thickness (mm)	Breaking force (kg)	
TCS1200	1200	47-1/4"	850 x 850	6-15	800
TCS1600	1600	63"	1130 x 1130	6-15	800

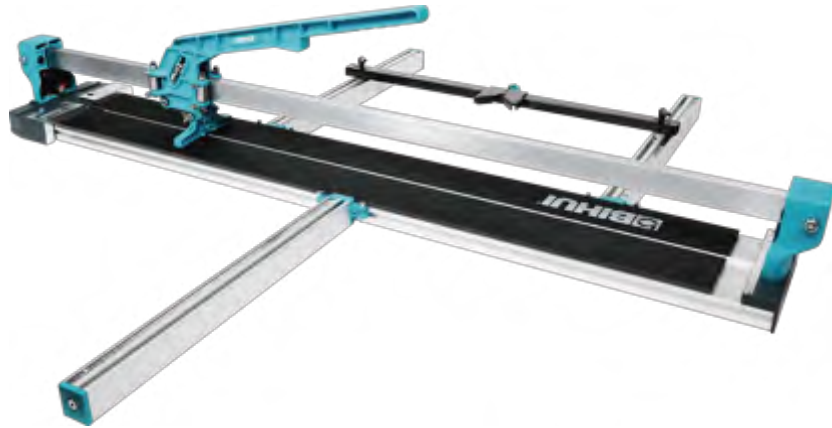

Professional Tile Cutter

- ▲ Aluminum die casting one-piece base, strong and durable
- ▲ Single guide rail with built-in ball bearing system, easy for cutting big tiles
- ▲ Ergonomic soft grip handle, labour-saving
- ▲ Extension bars to support large tiles
- ▲ Magnetic absorption breaking device, single-handed operation
- ▲ Gauge for straight and angled cutting, both in metric and inches
- ▲ Ø7/8"(22mm) scoring wheel included, quick replacement design



Art.No	Cutting Length	Diagonal Cutting Length(mm)	Cutting Thickness (mm)	Breaking force (kg)	
TCC900	900	36"	635 x 635	4-16	800
TCC1200	1200	47-1/4"	850 x 850	4-16	800
TCC1650	1650	65"	1165 x 1165	4-16	800

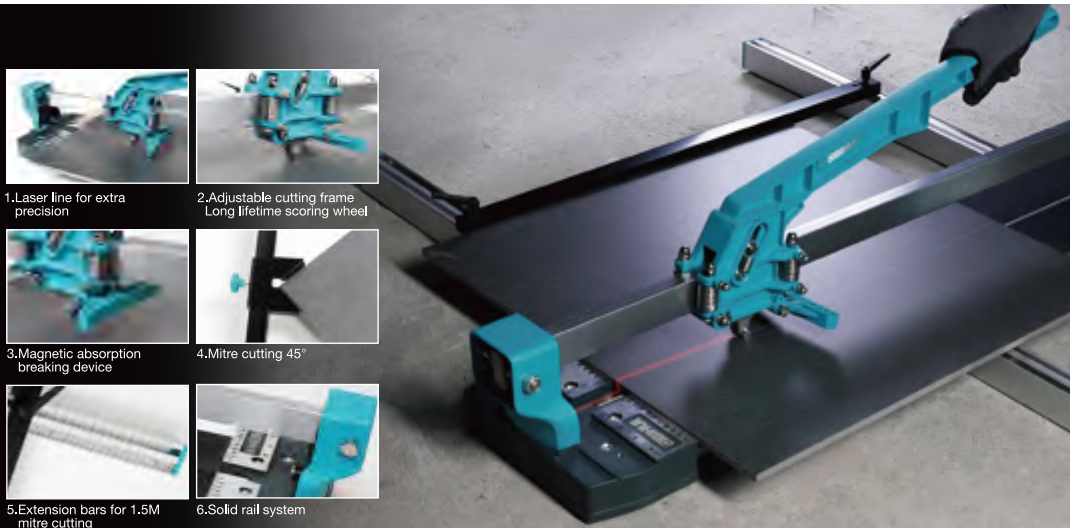

1. Laser line for extra precision
2. Adjustable cutting frame
Long lifetime scoring wheel
3. Magnetic absorption breaking device
4. Mitre cutting 45°
5. Extension bars for 1.5M mitre cutting
6. Solid rail system

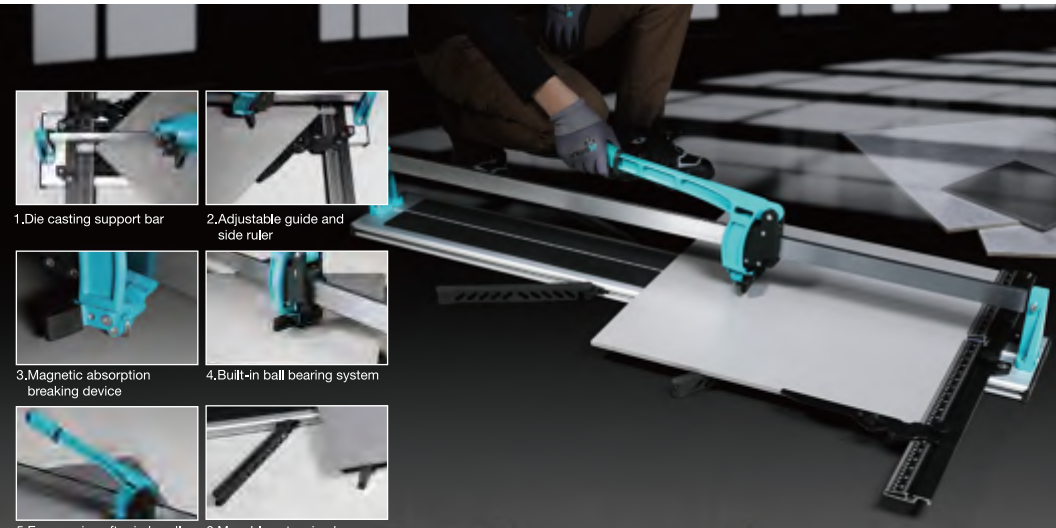

1. Die casting support bar
2. Adjustable guide and side ruler
3. Magnetic absorption breaking device
4. Built-in ball bearing system
5. Ergonomic soft grip handle
6. Movable extension bars

TILE CUTTER

Fast Tile Cutter

- ▲ One piece aluminum alloy base
- ▲ Solid single rail system
- ▲ Long lifetime scoring wheel Ø22mm
- ▲ Suitable for 90° and 45° cutting
- ▲ Laser and LED line for precision cutting
- ▲ For tiles, porcelain, ceramic and all kinds of tiles

Art.No	Cutting Length		Diagonal Cutting Length(mm)	Cutting Thickness (mm)	Breaking force (kg)
TCF700	700	27-1/2"	490 x 490	5-14	800
TCF1000	1200	40"	700 x 700	5-14	800
TCF1200	1600	47-1/4"	840 x 840	5-14	800

NEW



Martial Tile Cutter

- ▲ Metal structure base with spring and hollow base plate
- ▲ Single guide rail with 10 ball bearings and labor-saving handle
- ▲ Flat iron welding intermediate ribs
- ▲ Strong steel support bar
- ▲ Magnet breaking design
- ▲ Gauge for straight and angled cutting
- ▲ With transport wheels and handles.

Art.No	Cutting Length		Diagonal Cutting Length(mm)	Cutting Thickness (mm)	Breaking force (kg)
TCM700	700	27-1/2"	495 x 495	5 - 16	800
TCM900	900	36"	635 x 635	5 - 16	800
TCM1200	1200	47-1/4"	850 x 850	5 - 16	800
TCM1650	1650	65"	1165 x 1165	5 - 16	800

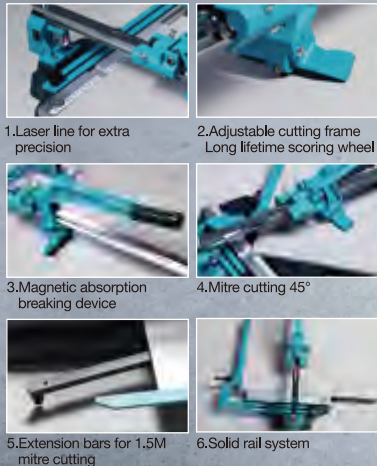
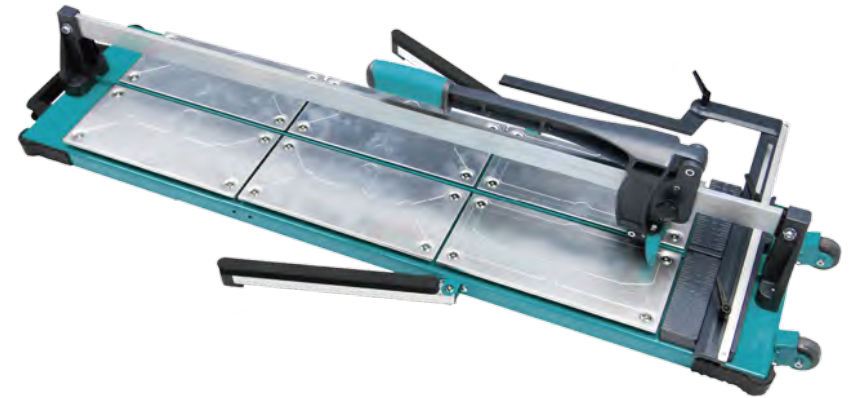

1. Laser line for extra precision
2. Adjustable cutting frame Long lifetime scoring wheel
3. Magnetic absorption breaking device
4. Mitre cutting 45°
5. Extension bars for 1.5M mitre cutting
6. Solid rail system



1. Breaking Device



2. Transport Wheels



3. Adjustable cutting frame Long lifetime scoring wheel



4. Ball bearings x 10



5. With adjustable cutting guides for 0° and 45° cuts



6. Metal base with spring



Automatic Electric Tile Cutting Machine

- ▲ For straight and 45° cut, diagonal cut, bullnose edges etc
- ▲ Built with a water pump and laser line
- ▲ Folding legs with built-in wheels for transportation
- ▲ Max. cutting depth: 30mm
- ▲ Suitable for cutting ceramics, stoneware, porcelain and other materials
- ▲ 1.6M, 1.8M, 2.4M, 3.0M available

Technical Data		
Art.No	TCSA1200	TCSA1200A
Output	3000W	3000W
Voltage	230V/50Hz	110V/60Hz
Speed	12,000RPM	12,000RPM
Cutting blade	120x20x1.3mm	4-3/4"x3/4"x1/16"
Max.cutting blade	135x20x10mm	5-1/4"x3/4"x3/8"
Max cutting depth	30mm	1-3/16"
Max cutting angle	45°	45°
Diagonal Cutting Length(cm)	850x 850	33-1/2"x 33-1/2"
Cutting Length	1200mm	48"



Tile Saw 10"

- ▲ Equipped with movable stand, easy to store and move
- ▲ With LED light & laser light, making cutting more accurate
- ▲ Cutting precision: 1/36"
- ▲ Max cutting depth: 3.75"
- ▲ Straight cutting: 36"
- ▲ Diagonal cutting: 24"
- ▲ Cutting capacity: 3.75"(90°), 1.5" (45°)
- ▲ Blade diameter: 10"
- ▲ Bevel Range: 0-45°
- ▲ Cutting material: Tile, Marble



Technical Data		
Art.No	TCSTW10	TCSTW10A
Voltage	230V/50Hz	110V/60Hz
Power	1800W-15A	1800W-15A
Speed	4500RPM	4500RPM
Blade diameter	250mm(10")	250mm(10")
Max cutting thickness	85mm(3.75")	85mm(3.75")
Cutting angle range	0-45°	0-45°
Table size	36"x24"	36"x24"

2TS
2cm tile solution



COMING SOON

Electric Cutting System for 2cm tiles

- ▲ One-piece aluminum alloy guide rail
- ▲ Die-cast aluminum alloy parts
- ▲ Can cut a variety of ceramic tiles from 4 to 22mm
- ▲ Adjustable length for different purpose
- ▲ Ergonomic soft handle
- ▲ Smooth sliding, stable cutting, no dust pollution.

NEW



ANGLE GRINDER

5" Variable Speed Angle Grinder

- ▲ With constant speed soft start
- ▲ Spindle Thread M14
- ▲ 6 variable gears from 3,000-11,000RPM
- ▲ With 3M cord and power-off protection
- ▲ 2-position TPR side handle
- ▲ Includes wrench, guard, side handle, carbon brushes

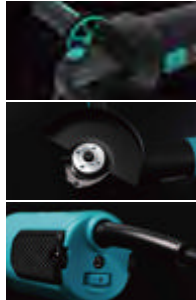

Technical Data	
Art.No	AG1200
Output	1200W
Voltage	230V/50Hz
Speed	3000-11000RPM

Suitable for Drilling, Cutting and Polishing



DRILLING



CUTTING



POLISHING

COMING SOON

5" Variable Speed Angle Grinder

- ▲ With constant speed soft start
- ▲ Spindle Thread M14
- ▲ 6 variable gears from 3,000-11,000RPM
- ▲ With 3M cord and power-off protection
- ▲ 2-position TPR side handle
- ▲ Includes wrench, guard, side handle, carbon brushes

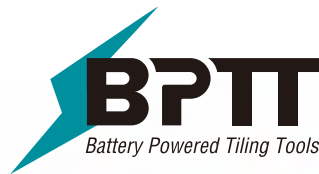

Technical Data	
Art.No	AGBP12
Output	1200W
Voltage	230V/50Hz
Speed	3000-11000RPM

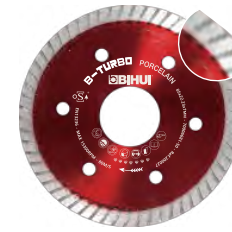

Diamond Blade

- ▲ Full 7mm height continuous diamond rim
- ▲ Suitable for cutting Hard Tiles, Marble, Slim Slab etc



Art.No					
DCDT85	85mm	3-3/8"	22.23mm	7	

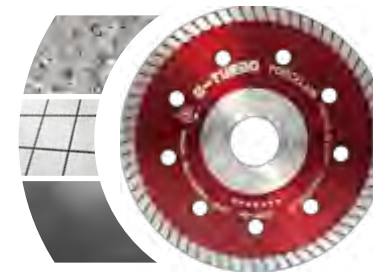

Diamond Blade

- ▲ Full 7mm height continuous diamond rim
- ▲ Central bore reinforced with 55mm double flange
- ▲ Suitable for cutting Hard Tiles, Marble, Slim Slab etc



Art.No					
DCDT115	115mm	4-1/2"	22.23mm	7	
DCDT125	125mm	5"	22.23mm	7	



Diamond Blade

- ▲ Full 7mm height continuous diamond rim
- ▲ Central bore reinforced with 70mm double flange
- ▲ Suitable for cutting Hard Tiles, Marble, Slim Slab etc



Art.No					
DCDT200	200mm	8"	25.4mm - 22.23mm	7	
DCDT230	230mm	9"	25.4mm - 22.23mm	7	



Diamond Blade

- ▲ Full 10mm height continuous diamond rim
- ▲ Central bore reinforced with 55mm double flange
- ▲ Suitable for cutting Hard Tiles, Porcelain Tiles, Ceramic Tiles etc



Art.No					
DCDB115	115mm	4-1/2"	22.23mm	10	
DCDB125	125mm	5"	22.23mm	10	



Diamond Blade

- ▲ Full 10mm height continuous diamond rim
- ▲ Central bore reinforced with 55mm double flange
- ▲ Suitable for cutting Hard Tiles, Porcelain tiles, Ceramic tiles etc



Art.No					
DCDA115	115mm	4-1/2"	22.23mm	10	
DCDA125	125mm	5"	22.23mm	10	

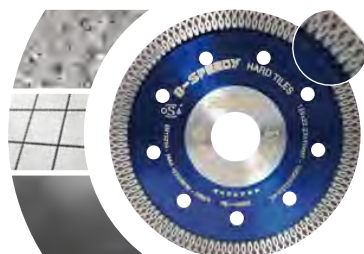

Diamond Blade

- ▲ Full 10mm height continuous diamond rim
- ▲ Central bore reinforced with 55mm double flange
- ▲ Suitable for cutting Hard Tiles, Porcelain Tiles, Ceramic Tiles etc



Art.No					
DCDM115	115mm	4-1/2"	22.23mm	10	
DCDM125	125mm	5"	22.23mm	10	

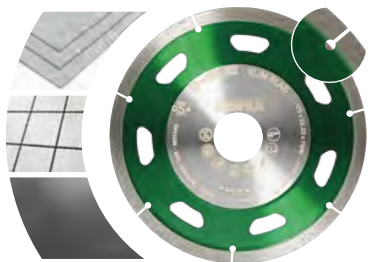

Diamond Blade

- ▲ Full 7mm height continuous diamond rim
- ▲ Central bore reinforced with 70mm double flange
- ▲ Suitable for cutting Slim Slab, Porcelain Tiles, Ceramic Tiles etc



Art.No					
DCDS115	115mm	4-1/2"	22.23mm	7	
DCDS125	125mm	5"	22.23mm	7	



Diamond Blade

- ▲ Full 10mm height continuous diamond rim
- ▲ Suitable for cutting Mosaic Tiles, Glass mosaic, Stone mosaic etc



Art.No					
DCDC115	115mm	4-1/2"	22.23mm	10	
DCDC125	125mm	5"	22.23mm	10	
DCDC180	125mm	7"	22.23mm	10	



Diamond Blade

- ▲ Full 10mm height continuous diamond rim
- ▲ Central bore reinforced with 55mm double flange
- ▲ Suitable for cutting Porcelain, Marble, Slim Slab



Art.No					
DCDW115	115mm	4-1/2"	22.23mm	10	
DCDW125	125mm	5"	22.23mm	10	



Diamond Blade

- ▲ Full 10mm height continuous diamond rim
- ▲ Thin 1.4mm thickness for less dust and faster cuts
- ▲ Central bore reinforced with 55mm double flange
- ▲ Steel body is made with special steel for additional rigidity
- ▲ High speed cutting with minimal chipping and self cooling
- ▲ Suitable for cutting Hard Tiles, Porcelain Tiles, Ceramic Tiles etc



Art.No					
DCDV125	125mm	5"	22.23mm	10	



Diamond Blade

- ▲ Full 12mm height rim with four special "W"
- ▲ Thick 2.4mm body for universal cutting purpose
- ▲ Suitable for cutting Granite, Stone and Hard Bricks etc.



Art.No					
DCDF115	115mm	4-1/2"	22.23mm	12	



Diamond Blade

- ▲ 4mm height segment diamond rim
- ▲ 2.4mm thickness for steady cutting
- ▲ Suitable for cutting Stainless, Ceramic, Concrete, Masonry, Plastic, Light Wood



Art.No					
DSBS115	115mm	4-1/2"	22.23mm	4	
DSBS125	125mm	5"	22.23mm	4	
DSBS180	180mm	7"	22.23mm	5	



Diamond Blade

- ▲ Full 12mm height rim with four special "W"
- ▲ Thick 2.4mm body for universal cutting purpose
- ▲ Suitable for cutting Granite, Stone and Hard Bricks etc.



Art.No					
DCDF125	125mm	5"	22.23mm	12	



Diamond Blade

- ▲ Full 3mm height continuous diamond rim
- ▲ 1.4mm thickness for slim cutting
- ▲ Suitable for cutting Aluminium, Steel Pipe, Steel Sheet, Angle Iron, PVC Pipe, Rebar



Art.No					
DSBC115	115mm	4-1/2"	22.23mm	3	
DSBC125	125mm	5"	22.23mm	3	
DSBC180	180mm	7"	22.23mm	4	



Diamond Blade

- ▲ Full 12mm height rim with four special "W"
- ▲ Thick 2.4mm body for universal cutting purpose
- ▲ Suitable for cutting Granite, Stone and Hard Bricks etc.



Art.No					
DCDF230	230mm	9"	22.23mm	12	



Diamond Blade

- ▲ 3mm height segment music slot diamond rim
- ▲ 1.4mm thickness for slim cutting
- ▲ Suitable for cutting Aluminium, Steel Pipe, Drywall, Plastic, Light Wood, Fiber Cement



Art.No					
DSBM115	115mm	4-1/2"	22.23mm	3	
DSBM125	125mm	5"	22.23mm	3	
DSBM180	180mm	7"	22.23mm	4	



Wet Continuous Rim Diamond Blade

- ▲ Full 7.5mm height continuous diamond rim
- ▲ Thin 1.6mm thickness for less dust and faster cuts
- ▲ High speed cutting with minimal chipping and self cooling

Art.No						
DCBG115	115mm	4-1/2"	22.23mm	7.5		



Super Narrow Teeth Diamond Blade

- ▲ Dry cutting depth upto 20mm
- ▲ Reinforced flange & Long lifetime
- ▲ Fine cuts and less dust
- ▲ Suitable for Tiles, marble, natural and artificial stone

Art.No						
DCBN115	115mm	4-1/2"	22.23mm	10		
DCBN5	125mm	5"	22.23mm	10		



Super Thin Turbo Diamond Blade

- ▲ Dry cutting depth upto 20mm
- ▲ Reinforced flange & Long lifetime
- ▲ Fine cuts and less dust
- ▲ Suitable for Tiles, marble, natural and artificial stone

Art.No						
DCBT115	115mm	4-1/2"	22.23mm	7.5		
DCBT5	125mm	5"	22.23mm	7.5		



Segment Diamond Blade

- ▲ Full 10mm height continuous diamond rim
- ▲ Thick 1.8mm body for universal cutting purpose
- ▲ Steel body is made with special steel for additional rigidity
- ▲ High speed cutting with minimal chipping and self cooling
- ▲ Perfect for use with angle grinder
- ▲ Suitable for cutting Hard Tiles , Porcelain tiles, Ceramic tiles etc.

Art.No						
DCBS120	120mm	4-3/4"	20.00mm	10		

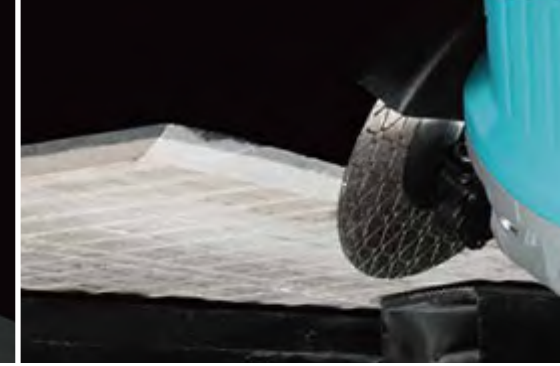
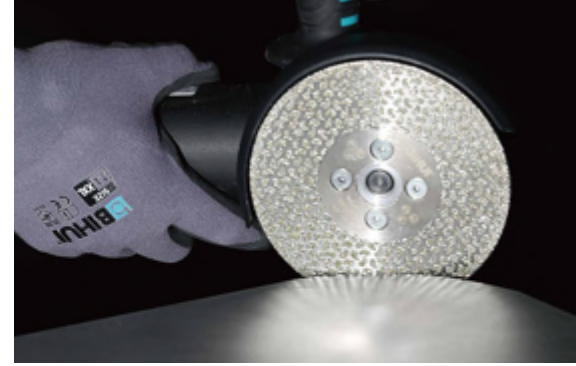

Vacuum Brazed Diamond Cutting & Grinding Wheel

- ▲ Designed for bevelling, small cuts, grinding, rounding and shaping edges and corners
- ▲ Suitable for materials like porcelain, marble and granite etc.



Art.No				MAX RPM		
DCWMM115A	115mm	4-1/2"	5/8"-11	13300		
DCWMM115	115mm	4-1/2"	M14	13300		
DCWMM5	125mm	5"	M14	12250		

Electroplated Diamond Cutting and Grinding Wheel

- ▲ Designed for bevelling, small cuts, grinding, rounding and shaping edges and corners
- ▲ Suitable for materials like porcelain, marble and granite etc.



Art.No				MAX RPM		
DCWME115A	115mm	4-1/2"	5/8"-11	13300		
DCWME5	125mm	5"	M14	12250		

Edge Cutting & Grinding Blade

- ▲ Full 25mm height continuous diamond rim
- ▲ 2.0mm thickness with provided strength and rigidity
- ▲ High speed cutting with minimal chipping and self cooling
- ▲ Suitable for cutting Hard Tiles , Porcelain tiles, Ceramic tiles etc.



Art.No				MAX RPM		
DPE125	125mm	5"	22.23mm	12250		

Diamond Cutting and Grinding Blade

- ▲ Full 30mm height diamond rim
- ▲ Thin 1.0mm thickness for faster cuts
- ▲ High speed cutting with minimal chipping
- ▲ Suitable for cutting Glass, Porcelain Tiles , Slab etc.



Art.No				MAX RPM		
DPG115	115mm	4-1/2"	22.23mm	13300		
DPG125	125mm	5"	22.23mm	12250		

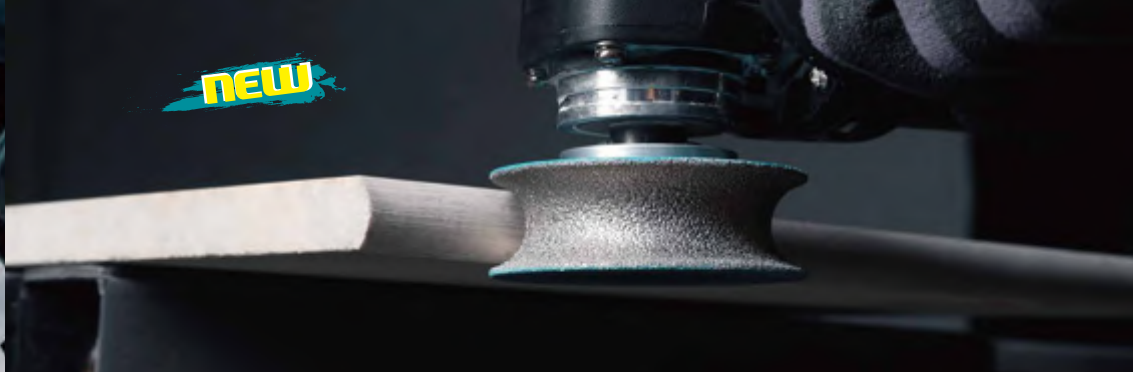

Mini Diamond Blade

- ▲ For fast and precise cutting with great adaptability
- ▲ Ideal for cutting ceramic tiles, porcelain, marble and stone

Art.No					
DCW50	50mm	2"	M14	6	
DCW50A	50mm	2"	5/8"-11	6	
DCW60	60mm	2-3/8"	M14	6	
DCW60A	60mm	2-3/8"	5/8"-11	6	



Mini Diamond Cup Wheel

- ▲ For fast grinding in tight areas
- ▲ Ideal for grinding concrete, screed and adhesive
- ▲ Turn by hand to check concentric rotation

Art.No					
DGW50	50mm	2"	M14	6	
DGW50A	50mm	2"	5/8"-11	6	

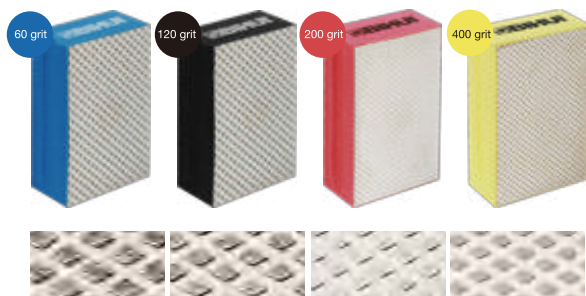

Diamond Hand Pad

- ▲ For wet & dry grinding edges and surfaces
- ▲ Suitable for tile, porcelain, marble and glass
- ▲ Use the entire diamond surface for the best results
- ▲ Size: 55 x 95mm

Art.No	Grit
DHP060	60#
DHP120	120#
DHP200	200#
DHP400	400#



Premium Bullnose Grinding Wheel

- ▲ Bullnose design for quick bevelling
- ▲ Medium grit for general grinding
- ▲ Perfect for use with angle grinder
- ▲ Suitable for grinding Hard Tiles, Porcelain tiles, Ceramic tiles etc.

Art.No		Thickness	MAX RPM	
DGW310	75mm	3"	10mm 11000	
DGW315	75mm	3"	15mm 11000	
DGW320	75mm	3"	20mm 11000	



Demi-Bullnose Grinding Wheel

- ▲ Demi-Bullnose design for quick bevelling
- ▲ Medium grit for general grinding
- ▲ Perfect for use with angle grinder
- ▲ Suitable for grinding Hard Tiles, Porcelain tiles, Ceramic tiles etc.

Art.No		Thickness	MAX RPM	
DGV310	75mm	3"	10mm 11000	
DGV315	75mm	3"	15mm 11000	
DGV320	75mm	3"	20mm 11000	



Round Grinding Wheel



- ▲ Round design for quick bevelling
- ▲ Medium grit for general grinding
- ▲ Perfect for use with angle grinder
- ▲ Suitable for grinding Hard Tiles, Porcelain tiles, Ceramic tiles etc.

Art.No		Thickness	MAX RPM	
DGR310	75mm	3"	10mm 11000	
DGR315	75mm	3"	15mm 11000	
DGR320	75mm	3"	20mm 11000	



Universal Diamond Grinding Flap Wheel 2.0

- ▲ Spiral turbo design for aggressive and fast grinding
- ▲ Durable diamond and silicon carbide flaps
- ▲ Bore size 22,23, suitable for most angle grinder
- ▲ Upgraded stronger metal backing plate for longer lifetime
- ▲ Suitable for grinding and smoothing materials like porcelain, marble and granite etc



Art.No		Grit	MAX RPM	
DPS060	115mm	4-1/2" #60	10500	
DPS120	115mm	4-1/2" #120	10500	
DPS200	115mm	4-1/2" #200	10500	

NEW



Universal Diamond Grinding Flap Wheel

- ▲ Spiral turbo design for aggressive and fast grinding
- ▲ Durable diamond and silicon carbide flaps
- ▲ Bore size 22,23, suitable for most angle grinder
- ▲ Suitable for grinding and smoothing materials like porcelain, marble and granite etc

Art.No		Grit	MAX RPM	
DPF060	115mm	4-1/2" #60	10500	
DPF120	115mm	4-1/2" #120	10500	
DPF200	115mm	4-1/2" #200	10500	



Polishing Pad Holder

- ▲ Velcro connection to polishing pads
- ▲ Rubber Backing with M14 or 5/8"-11 thread

Art.No	Size	Thread
DPPH4	100mm (4")	M14
DPPH4A		5/8"-11



Diamond Polishing Pads

- ▲ Step 3 for a perfect job
- ▲ Sharp, durable, well finish
- ▲ Great for polishing flat surfaces and bevelled edges

NEW

Art.No	Size	Grit
DPW4S3	100mm(4")	1/2 / 3



Vacuum Brazed Diamond Polishing Pad

- ▲ Aggressive and well finish
- ▲ Great for polishing flat surface and bevelling edges
- ▲ Designed for tile, porcelain, marble and glass

Art.No	Size	Grit
DPV405	100mm (4")	#50
DPV410		#100

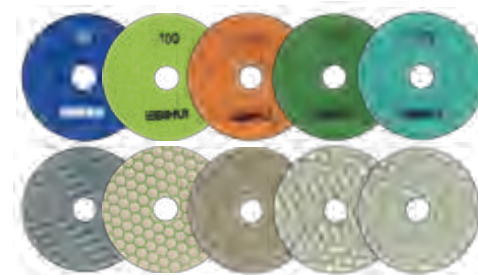

Diamond Polishing Pads

- ▲ Sharp, durable, well finish
- ▲ Great for polishing flat surfaces and bevelled edges
- ▲ Light color pad design
- ▲ Specially ideal for white and light color ceramic tiles and other materials

Art.No	Size	Grit
DPP405		#50
DPP410		#100
DPP420	100mm (4")	#200
DPP480		#800
DPP415		#1500





DOA
Diamond Order Arrangement



Turbo Dry Drill Bit 2.0

- ▲ Order arrangement diamond technology
- ▲ M14 or 5/8"-11 thread available to angle grinder
- ▲ Faster speed and longer lifetime
- ▲ Suggested RPM 11000
- ▲ Suitable for drilling porcelain, marble and granite etc.

Art.No	Size	Art.No	Size
DBDB06	6mm	DBDB55	55mm
DBDB08	8mm	DBDB57	57mm
DBDB10	10mm	DBDB60	60mm
DBDB12	12mm	DBDB65	65mm
DBDB20	20mm	DBDB68	68mm
DBDB25	25mm	DBDB70	70mm
DBDB28	28mm	DBDB75	75mm
DBDB30	30mm	DBDB82	82mm
DBDB35	35mm	DBDB100	100mm
DBDB40	40mm	DBDB115	115mm
DBDB50	50mm	DBDB120	120mm



NEW



More sizes available

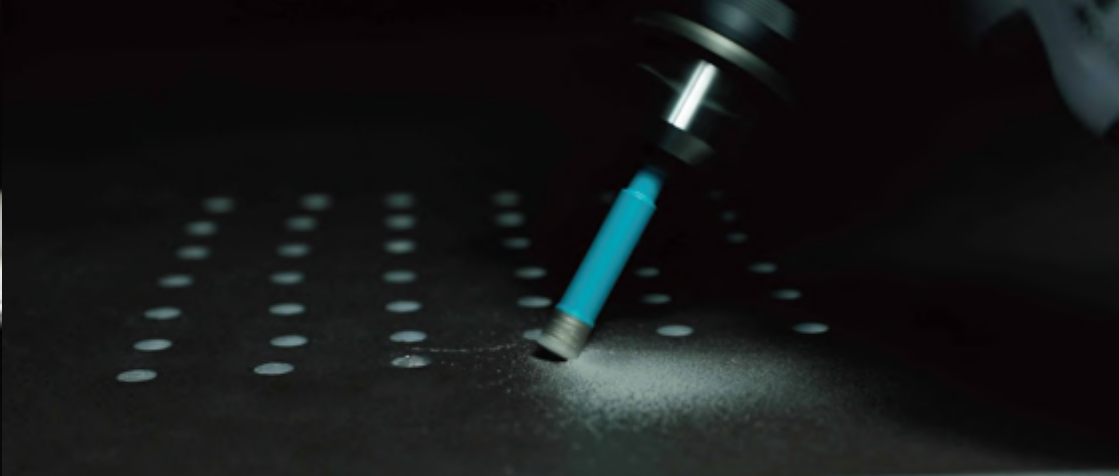

Turbo Dry Drill Bit

- ▲ Vacuum brazed diamond drill bit
- ▲ M14 or 5/8"-11 thread to angle grinder
- ▲ Fast speed and long lifetime
- ▲ Suggested RPM 11000
- ▲ Suitable for drilling porcelain, marble and granite



Art.No	Size	Art.No	Size
DBDF06	6mm	DBDF55	55mm
DBDF08	8mm	DBDF57	57mm
DBDF10	10mm	DBDF60	60mm
DBDF12	12mm	DBDF65	65mm
DBDF20	20mm	DBDF68	68mm
DBDF25	25mm	DBDF70	70mm
DBDF28	28mm	DBDF75	75mm
DBDF30	30mm	DBDF82	82mm
DBDF35	35mm	DBDF100	100mm
DBDF40	40mm	DBDF115	115mm
DBDF50	50mm	DBDF120	120mm



More sizes available

	1	2	3	4	5
Porcelain					
Marble					
Travertine					
Granite					
Ceramic					

Lifetime

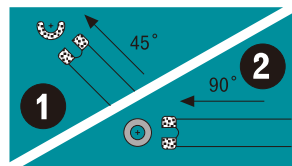

Quick Change Diamond Dry Drill Bit

- ▲ Quick clip handle to shaft drill
- ▲ Fast speed and long lifetime
- ▲ Suggested RPM 2500
- ▲ Suitable for drilling porcelain, marble and granite

Art.No	Size	
DBDQ05	5mm	3/16"
DBDQ06	6mm	1/4"
DBDQ07	7mm	9/32"
DBDQ08	8mm	5/16"
DBDQ10	10mm	3/8"
DBDQ12	12mm	1/2"
DBDQ14	14mm	9/16"
DBDQ20	20mm	3/4"



More sizes available



Cooling Wax

- ▲ For cooling tile drill bit
- ▲ Prolonger lifetime and drilling speed

Art.No	Size
DBCW20	20-25ml
DBCW30	30ml
DBCW50	50ml
DBCW100	100pcs



Drill Chuck Adaptor

- ▲ For converting M14 thread into hexagon connection for drill machine
- ▲ Suggested MIN RPM 2500

Art.No	Size
DBAMH	M14-Hexagon
DBAAH	5/8"-11-Hexagon



SUITABLE FOR
PORCELAIN & HARD TILES



USE DRY



USE WITH
ANGLE GRINDER 11000 RPM



Diamond Turbo Drill Set

- ▲ Vacuum brazed diamond drill bit
- ▲ M14 connection to angle grinder
- ▲ Hexagon adaptor for electric drill
- ▲ Fast speed and long lifetime
- ▲ Drills in size Ø6x64, Ø8x64, Ø20x74, Ø35x74, Ø50x74, Ø70x74mm

Art.No	Kit
DBDMK6	6pcs Set



Diamond Turbo Drill Set

- ▲ Vacuum brazed diamond drill bit
- ▲ M14 connection to angle grinder
- ▲ Hexagon adaptor for electric drill
- ▲ Fast speed and long lifetime
- ▲ Drills in size Ø6x64, Ø8x64, Ø10x64, Ø12x64mm & Adaptor

Art.No	Kit
DBDMK5	5pcs Set



Diamond Turbo Drill Set

- ▲ Vacuum brazed diamond drill bit
- ▲ M14 connection to angle grinder
- ▲ Hexagon adaptor for electric drill
- ▲ Fast speed and long lifetime
- ▲ Drills in size Ø25x74, Ø35x74, Ø40x74, Ø45x74, Ø50x74, Ø68x74mm

Art.No	Kit
DBDMS6	6pcs Set



Diamond Turbo Drill Set

- ▲ Vacuum brazed diamond drill bit
- ▲ M14 connection to angle grinder
- ▲ Fast speed and long lifetime
- ▲ Drills in size Ø25x74, Ø40x74, Ø60x74, Ø70x74mm

Art.No	Kit
DBDMK4	4pcs Set



Diamond Turbo Drill Set

- ▲ Vacuum brazed diamond drill bit
- ▲ Vacuum brazed diamond grinding bit
- ▲ M14 connection to angle grinder
- ▲ Fast speed and long lifetime
- ▲ Drill in size 25x74, 35x74, 40x74, 45x74, 68x74mm
- ▲ Finger bit in 20mm & cone bit in 20-48mm

Art.No	Kit
DBDMS7	7pcs Set



Diamond Turbo Drill Set

- ▲ Vacuum brazed diamond drill bit
- ▲ M14 connection to angle grinder
- ▲ Fast speed and long lifetime
- ▲ Drills in size Ø20x74, Ø35x74, Ø55x74, Ø60x74mm, Ø75x74mm

Art.No	Kit
DBDMS5	5pcs Set



Diamond Turbo Drill Set

- ▲ Vacuum brazed diamond drill bit
- ▲ M14 connection to angle grinder
- ▲ Fast speed and long lifetime
- ▲ Drill in size 25x74, 35x74, 40x74, 45x74, 50x74, 68x74mm
- ▲ Finger bit in 20mm & cone bit in 20-48mm
- ▲ Cutting disc in 125mm & cooling gel

Art.No	Kit
DBDMS10	10pcs Set

 SUITABLE FOR PORCELAIN & HARD TILES

 USE DRY

 USE WITH ANGLE GRINDER 11000 RPM

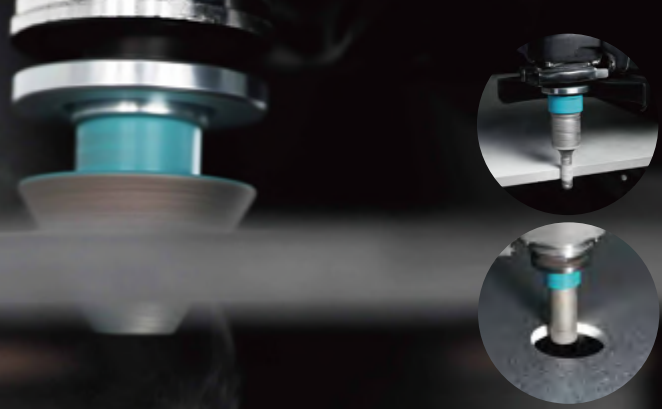

Diamond Mill

- ▲ Medium grit
- ▲ Suggested MIN RPM 1500
- ▲ For enlarge or polishing holes after drilling

Art.No	Size	Thread
DMB10	10mm 3/8"	M14
DMB10A	10mm 3/8"	5/8"-11



Diamond Mill

- ▲ Medium grit
- ▲ Suggested MIN RPM 1500
- ▲ For enlarge or polishing holes after drilling

Art.No	Size	Thread
DMB20	20mm 3/4"	M14
DMB20A	20mm 3/4"	5/8"-11



Multi-Function Diamond Mill

- ▲ Medium grit
- ▲ Suggested min. RPM 1500
- ▲ Available in M14 or 5/8"-11
- ▲ For enlarge or polishing holes after drilling
- ▲ Chamfering 0-10mm, Ø10mm, 10-25mm, Ø25mm, Ø25-48mm

Art.No	Size	Thread
DM4N1	4 in 1	M14
DM4N1A	4 in 1	5/8"-11



Diamond Mill

- ▲ Medium grit, Conical top
- ▲ Suggested MIN RPM 1500
- ▲ For enlarge or polishing holes after drilling

Art.No	Size	Thread
DMC238	2-38mm	M14
DMC238A	2-38mm	5/8"-11



Diamond Mill

- ▲ Medium grit, Flat top
- ▲ Suggested MIN RPM 1500
- ▲ For enlarge or polishing holes after drilling

Art.No	Size	Thread
DMF2048	20-48mm	M14
DMF2048A	20-48mm	5/8"-11



Diamond Mill

- ▲ Medium grit, Flat top
- ▲ Suggested MIN RPM 1500
- ▲ For enlarge or polishing holes after drilling

Art.No	Size	Thread
DMF3575	35-75mm	M14
DMF3575A	35-75mm	5/8"-11





Technical Data	
Art.No	AG1400A
Output	1400W
Voltage	110V/60hz
Speed	3000-10000RPM
Diameter	115mm(4-1/2"/125mm(5"))
Thread	5/8"-11

5" Variable Speed Angle Grinder

- ▲ With constant speed soft start
- ▲ Spindle Thread 5/8"-11
- ▲ 6 variable gears from 3,000-10000RPM
- ▲ With 3M cord and power-off protection
- ▲ 2-position TPR side handle quick change blade cover
- ▲ Quick change blade cover
- ▲ Includes wrench, guard, side handle, carbon brushes

Suitable for Drilling, Cutting and Polishing

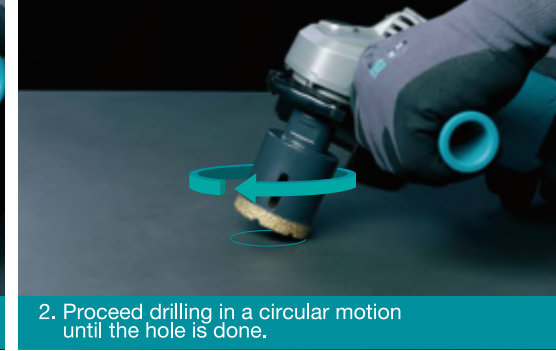
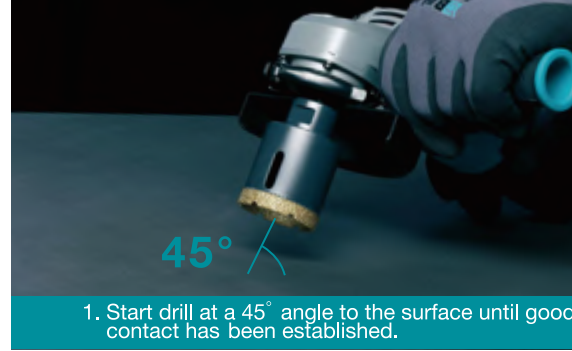

Turbo Dry Drill Bit

- ▲ Vacuum brazed diamond drill bit
- ▲ M14 or 5/8"-11 thread to angle grinder
- ▲ Fast speed and long lifetime
- ▲ Suggested RPM 11000
- ▲ Suitable for drilling porcelain, marble and granite

Art.No	Size	Art.No	Size
DBDA05	3/16"	DBDA45	1-3/4"
DBDA06	1/4"	DBDA50	2"
DBDA08	5/16"	DBDA55	2-3/16"
DBDA10	3/8"	DBDA60	2-3/8"
DBDA12	1/2"	DBDA65	2-1/2"
DBDA20	3/4"	DBDA68	2-5/8"
DBDA28	1-1/8"	DBDA70	2-3/4"
DBDA30	1-3/16"	DBDA75	3"
DBDA35	1-3/8"	DBDA82	3-1/4"
DBDA38	1-1/2"	DBDA100	4"
DBDA40	1-5/8"	DBDA115	4-1/2"

More sizes available

Porcelain					
Marble					
Travertine					
Granite					
Ceramic					

Lifetime

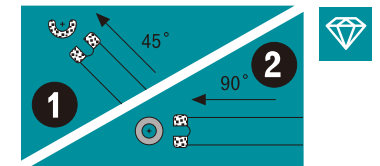



Vacuum Brazed Diamond Mills Set

- ▲ 5/8"-11 connection to angle grinder
- ▲ 5/8"-11 to Hexagon adaptor for electric drill machine
- ▲ Perfect for enlarge/polishing holes with long lifetime
- ▲ Diamond mills in 3/8" (10mm), 3/4" (20mm), 3/32"-1-1/2" (2-38mm), 3/4"-1-7/8" (20-48mm)
- ▲ Wax for diamond dry drills or mills

Art.No	Kit
DBDAS6	6pcs Set



Diamond Turbo Drill Set

- ▲ Vacuum brazed diamond drill bit
- ▲ 5/8"-11 connection to angle grinder
- ▲ Hexagon adaptor for electric drill
- ▲ Fast speed and long lifetime
- ▲ Drills in size Ø6x64, Ø8x64, Ø20x74, Ø35x74, Ø50x74, Ø70x74mm

Art.No	Kit
DBDAK6	6pcs Set



Vacuum Brazed Diamond Mills Set

- ▲ 5/8"-11 connection to angle grinder
- ▲ 5/8"-11 to Hexagon adaptor for electric drill machine
- ▲ Drill guide master for holes from 4mm to 115mm
- ▲ Perfect for enlarge/polishing holes with long lifetime
- ▲ Diamond mills in 3/8" (10mm), 3/4" (20mm), 3/32"-1-1/2" (2-38mm), 3/4"-1-7/8" (20-48mm)
- ▲ Wax for diamond dry drills or mills

Art.No	Kit
DBDAS7	7pcs Set



Vacuum Brazed Diamond Mills and Drill Bits Set

- ▲ 5/8"-11 connection to angle grinder
- ▲ 5/8"-11 to Hexagon adaptor for electric drill machine
- ▲ Drill guide master for holes from 4mm to 115mm
- ▲ Perfect for enlarge/polishing holes with long lifetime
- ▲ Dry drills in size Ø1/2" (12mm), Ø3/4" (20mm), Ø4-1/2" (115mm)
- ▲ Diamond mills in 3/8" (10mm), 3/4" (20mm), 3/32"-1-1/2" (2-38mm), 3/4"-1-7/8" (20-48mm)
- ▲ Wax for diamond dry drills or mills

Art.No	Kit
DBDAS10	10pcs Set



Professional Diamond Tools Set

- ▲ Vacuum brazed diamond drill bit in size 20x74mm & 38x74mm
- ▲ Vacuum brazed diamond finger bit in 20mm & cone bit in 2-38mm
- ▲ Cutting disc in 115 & 125mm
- ▲ Pad holder & polishing pads in 100mm
- ▲ Hand pad in grit #60

Art.No	Size
DBDAS16	16pcs Set



Diamond Turbo Drill Set

- ▲ Vacuum brazed diamond drill bit
- ▲ 5/8"-11 connection to angle grinder
- ▲ Fast speed and long lifetime
- ▲ Drill in size 1/4", 5/16", 3/4", 1-3/8", 2", 2-3/4" & Adaptor

Art.No	Kit
DBDAK7	7pcs Set



Diamond Turbo Drill Set

- ▲ Vacuum brazed diamond drill bit
- ▲ 5/8"-11 connection to angle grinder
- ▲ Fast speed and long lifetime
- ▲ Drill in size 25x74, 35x74, 40x74, 45x74, 50x74, 68x74mm
- ▲ Finger bit in 20mm & cone bit in 20-48mm
- ▲ Cutting disc in 125mm & cooling gel

Art.No	Kit
DBDAK10	10pcs Set



Drill Guide Master

- ▲ Integrated water hole attach to cooling system for wet drilling
- ▲ For guiding hole saw drill from 4mm to 115mm
- ▲ Fixed hole size in 4,5,6,7,8,10,12,20,35mm
- ▲ Adjustable steel plate with maximum opening length 80mm
- ▲ For 81mm to 115mm drills, place the drills at the end of the guide
- ▲ Loose the screw, suction cup can be used individually with max. capacity of 35Kg (77lbs)
- ▲ Suction cup suitable for Tiles, Glass, Marble, Granite, etc.

Art.No	Size
DBGM	Universal



Universal Guide

- ▲ High quality suction pad for hole locating
- ▲ Integrated with steel plate for precise drilling
- ▲ ABS material with comfort nylon handle
- ▲ Suitable for drill sizes in 4,5,6,8,10,12,14mm

Art.No	Size
DBGU	Universal



Multi-Functional Adjustable Tile Hole Locator

- ▲ Made of 2,5mm aluminum alloy material, durable and perfect thickness
- ▲ Laser calibration in both centimeters and inches, easy and simple
- ▲ Six-sided foldable arms with 360°freely fixing knobs
- ▲ Guide in 25, 40, 45, 55 and 75mm drilling holes on tiles, glass, marble, granite etc.
- ▲ BIHUI unique comfort flower screw

Art.No	Size
DBG6	Universal



Electroplated Diamond Drill Bit

- ▲ Suitable for drilling porcelain, marble, granite, glass and travertine
- ▲ To maximize performance ensure drill is cooled with water



Art.No	Size	Art.No	Size
DBW06	6mm 1/4"	DBW45	45mm 1-3/4"
DBW08	8mm 5/16"	DBW50	50mm 2"
DBW10	10mm 3/8"	DBW55	55mm 2-3/16"
DBW12	12mm 1/2"	DBW68	68mm 2-5/8"
DBW20	20mm 3/4"	DBW75	75mm 3"
DBW25	25mm 1"	DBW100	100mm 4"
DBW35	35mm 1-3/8"	DBW120	120mm 4-3/4"



More sizes available

Diamond Drill and Mill Bit

- ▲ Drill bit tip for drilling holes
- ▲ Mill bit body for enlarge or even holes
- ▲ Suitable for drilling and milling porcelain, marble and granite

Art.No	Size
DMM20	20mm 3/4"
DMM35	35mm 1-3/8"
DMM50	50mm 2"
DMM68	68mm 2-5/8"



Drain Hole Open Dry Drill Bit

- ▲ Featured with hole size in 40mm and grinding diameter in 60mm
- ▲ Fast drilling and perfect grinding to floor drain installation

Art.No	Size
DBDP40	35mm 1-3/8"



Multi-Purpose Dust Box

- ▲ Suitable for drilling and cutting
- ▲ Dust hole connecting with vacuum machine
- ▲ Dust trash door underneath
- ▲ Soft handle for easy carry
- ▲ Light weight and solid structure

Art.No	Size
TDB	500x350x62mm (20"x14"x2-1/2")



Bucket Dust Collector

- ▲ Ideal for dust extraction in the filling and mixing process
- ▲ Quick clamping on the bucket with spring
- ▲ 3-steps rubber connector to the vacuum cleaner
- ▲ Fast extraction design for reduced dust
- ▲ Suitable for mixing bucket upto 35mm thickness
- ▲ Benefits to health and environment

Art.No	Size
TDBM	Universal





Drilling Dust Extractor

- ▲ Collects dust while drilling on wall or floor
- ▲ Designed also for guiding the hole drilling
- ▲ Universal rubber adaptor diam. 25-35mm
- ▲ Rubber sealing base largely prevents the leakage of fine dust
- ▲ Steel V frame for enhanced strength
- ▲ Suitable for tiles, concrete and bricks etc.

Art.No	Size
TDBS	Up to 72mm



Cutting Dust Extractor

- ▲ Collects dust while cutting tiles
- ▲ Can be used with BIHUI angle grinder
- ▲ Designed with level support for easily straight cutting
- ▲ Suitable for cutting disc in 115mm and 125mm

Art.No	Size
TDBC	Ø 115-125mm



Grinding Dust Extractor

- ▲ Better health and less cleaning due to dust-free grinding
- ▲ Universal vacuum cleaner connection:diam 25-35 mm
- ▲ Brush rim largely prevents the leakage of fine dust
- ▲ Adjustable front part allows edge work
- ▲ Adjustable snap closure for secure mounting on the angle grinder

Art.No	Size
DCWDE5	100-125mm
DCWDEB	Spare brush

Vacuum Brazed Coating & Glue Grinding Cup Wheel

- ▲ Spiked diamonds for aggressive and fast material removal as well as surface preparation
- ▲ Features with air holes designed to aid in and maintain a cool stable cutting pattern and reduced wear
- ▲ Reinforced compound technology with high durability against impact and abrasion
- ▲ Suitable for removing epoxy, adhesive residues, paint coatings etc, from concrete, granite, sandstone and building material



Art.No	Ø	Size	MAX RPM	
DCWG5	125mm	5"	22.23mm	12250
DCWG7	180mm	7"	22.23mm	8500



Dual-Row Cup Wheel

- ▲ Double row design for aggressive and fast material removal as well as surface preparation
- ▲ Features with air holes designed to aid in and maintain a cool stable cutting pattern and reduced wear
- ▲ Suitable for grinding, smoothing and for removing of adhesives and materials from concrete, granite, sandstone and building material

Art.No	Ø	Size	MAX RPM	
DCWD5	125mm	5"	22.23mm	12250
DCWD7	180mm	7"	22.23mm	8500



Turbo Cup Wheel

- ▲ Spiral turbo design for aggressive and fast material removal as well as surface preparation
- ▲ Features with large air holes designed to aid in and maintain a cool stable cutting pattern and reduced wear
- ▲ Suitable for grinding, smoothing and for removing of adhesives and materials from concrete, granite, sandstone and building material

Art.No	Ø	Size	MAX RPM	
DCWT5	125mm	5"	22.23mm	12250
DCWT7	180mm	7"	22.23mm	8500



Fan Cup Wheel

- ▲ Turbo fan design for aggressive and fast material removal as well as surface preparation
- ▲ Features with large air holes designed to aid in and maintain a cool stable cutting pattern and reduced wear
- ▲ Suitable for grinding and smoothing materials like concrete, granite, sandstone and building material

Art.No	Ø	Size	MAX RPM	
DCWF5	125mm	5"	22.23mm	12250
DCWF7	175mm	7"	22.23mm	8500



Arrow Cup Wheel

- ▲ Arrow segment design for aggressive and fast material removal as well as surface preparation
- ▲ Features with large air holes designed to aid in and maintain a cool stable cutting pattern and reduced wear
- ▲ Suitable for grinding and smoothing materials like concrete, granite, sandstone and building material as well as adhesive, epoxy and paint removal

Art.No	Ø	Size	MAX RPM	
DCWA5	125mm	5"	22.23mm	12250
DCWA7	175mm	7"	22.23mm	8500



Concrete Floor Grinder

- ▲ Made of durable aluminum alloy, metal and engineering nylon
- ▲ Ergonomic design characterized with the increased balance and flatness
- ▲ Suitable for almost all 180mm diamond or resin discs
- ▲ Featured with power-off & overloading protections, and speed regulation
- ▲ Full wave electronics, soft start, and with a start-current limit function
- ▲ Removable front protective cover with magnetic, convenient for corner grinding (inner corner)
- ▲ Self-cleaning design, equipped with professional vacuum cleaner interface, can be used in vacuum bag or vacuum cleaner, dust-free operation
- ▲ Removing old surfaces as well as preparing a new base for secondary renovation
- ▲ Suitable for materials like tile, concrete, etching, tile adhesive, natural stone, plaster, paint, coating, adhesive carpet etc.

Technical Data		Art.No			RIM
Art.No	CG1900	CG1900W	180mm(7")	22.23mm	Dual row
Output	1900W	CG1900-GW	180mm(7")	22.23mm	Spike 
Voltage	230V/50Hz				
Speed	0-3000RPM				
Cup Wheel	180mm(7")				



180mm Diamond or resin discs



Protective cover with magnetic

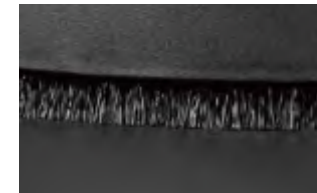

Dust-free brush



Connection pipe to vacuum cleaner



Constant speed and soft start



Variable speed switch





Working Stand for Concrete Grinder

- ▲ Working stand with 1.0-1.2M adjustable height and ergonomic handles
- ▲ With 2.5M cable, switch box and universal wheels and positioner device
- ▲ Suitable for BIHUI 1900W Concrete Grinder
- ▲ Save labor and energy when polishing or grinding large areas surfaces

Art.No	Size
CGWS19	1.0-1.2M(40")-(47-1/4")





Concrete Floor Grinder

- ▲ Made of durable aluminum alloy, metal and engineering nylon
- ▲ Ergonomic design characterized with the increased balance and flatness
- ▲ Featured with power-off & overloading protections, and speed regulation
- ▲ Full wave electronics, soft start, and with a start-current limit function
- ▲ Removing old surfaces as well as preparing a new base for secondary renovation
- ▲ Suitable for materials like tile, concrete, etching, tile adhesive, natural stone, plaster, paint, coating, adhesive carpet etc.

Technical Data	
Art.No	CG2000
Power:	2000W
Rated voltage:	230/110V
Frequency:	50/60HZ
Speed:	0-3000RPM
Cup wheel:	180mm(7")
VDE plug and 3m cable	



PATENTED

Dust class*	Maximum transmittance	Suitable for	Disposal
L 	≤ 1,0%	Dusts with OEL** values > 1³mg/m³ Domestic dust, soil, lime	—
M 	< 0,1%	Dusts with OEL** values ≥ 0,1mg/m³ Wood, screed, primer coat and paint, plaster, cement, concrete, tile adhesive, paints such as latex and oil paints, quartz containing materials such as sand and pebbles	Low dust
H 	< 0,005%	Dusts with OEL** values < 0,1³mg/m³ Carcinogenic dust, dust with pathogens, dust with bacteria	Dust free





Antistatic Hose 4M



Floor Brush



Handle



Wand



Plastic Crevice Tool



Reducer Adapter

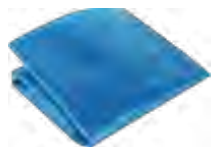

Dust Bag



Dust Collection Bag



Industrial Vacuum Cleaner 38L

- ▲ Innovative auto clean system ensure the vacuum works at high suction
- ▲ Equipped with 2 HEPA filters stops 99.95% of fine dusts at 0.3µm.
- ▲ Wet and dry for liquids and dry solids extraction
- ▲ Power socket for power tool use activates automatically
- ▲ Suction power control for adapted suction performance
- ▲ Automatic trailing mechanism for emptying the suction hose completely
- ▲ Robust wheels and castors built to withstand the tough construction site
- ▲ Cable wrap for convenient cord storage
- ▲ Practical accessory case and storage area.

Technical Data		
Art.No	VCA38	VCB38
Voltage / Frequency	230V/50Hz	110V/60Hz
Motor power (w)	1200W	1.85HP
Airflow (max)	262M ³ /H	153CFM
Water lift (Max)	250	104Inch
Filter efficiency	HEPA, >99.5%@0.3µm	
Filter cleaning	Innovated auto cleaning	
Airflow adjustable	adjustable	adjustable
Power socket	2000W	1200W
Remote control start	Optional	Optional
Tank capacity	38L	10Gal
Weight	13.5kg	30lbs
Dust Class	H class	



NEW

Vacuum Cleaner 35L

- ▲ High-quality stainless steel suction tubes
- ▲ Flow rate monitoring with warning LED and acoustic warning signal
- ▲ Hose diameter selector switch Robust chassis with extra-large, construction site suitable wheels and swivel castors
- ▲ Adjustable, foldable push bar for easy transport
- ▲ Constantly high air flow also during filter cleaning
- ▲ Electronic soft start with deferred rundown switching
- ▲ Power socket with automatic switch-on for attached machine
- ▲ Water recognition with sensor disconnection
- ▲ Special plastic bag for clean disposal - Transport closure by sealing plug

Technical Data		
Art.No	VCM35	VCL35
Voltage / Frequency	230V/50Hz	110V/60Hz
Motor power (w)	1200W	1080W
Airflow (max)	250 mbar	153CFM
Water lift (Max)	250	104 inch
Airflow adjustable	adjustable	adjustable
Power socket	2000W	1200W
Tank capacity	35L	9.25Gal
Weight	16Kg	35 lbs
Dust Class	M class	
Suction hose 35mm	5M	5M
Suction hose 38mm	2.5M	2.5M
Noise(LpA)	LpA 74dB(A)	LpA 74dB(A)
Dimension(LxWxH)	54x39x63.5cm	54x39x63.5cm



Suction hose D35 5M anti-static, oil-resistant



Suction hose D38 2.5M anti-static, oil-resistant



Power tool adapter Ø21, 25, 32mm
Power tool adapter Ø35mm



Dry floor nozzle 450mm



Crevice nozzle



Round nozzle Ø 75mm



HEPA 13 cartridge filter



Vacuum tubes, stainless steel, 2 x 0,5M



Fleece filter bag



Disposal bag



VACUUM CLEANER



Vacuum Cleaner 30L

- ▲ Suitable for extracting solid particles (dust and cutting waste) and water
- ▲ Semi-automatic HEPA filter cleaning system
- ▲ Blower function
- ▲ Dust full indicator
- ▲ Power tool socket function
- ▲ On-board accessory storage
- ▲ Drain device for convenient liquid disposal
- ▲ Convenient hose hook for easy transport and storage

Technical Data	
Art.No	VCH30
Voltage / Frequency	230V/50Hz
Motor power (w)	1200W
Airflow (m³ / min)	≥1.8
Vacuum pressure (KPa)	16.5±1.5
Noise (LpA)	≤70
Tank capacity (L)	30
Electrical cord Length (m)	2.3
Lifetime (H)	350
Protection class	IPX4
New weight	9.5Kg
Power socket for electro portable tool max. 2,000W	

Manufacturer reserves the right to change specifications without notice. Specifications may differ from country to country



Hose Tube



Wet Use Floor Brush
For also sucking water



Carpet Floor Brush
For carpet use



Sofa Brush
For curtains and funitures



Round Brush
For sawdust etc.



Crevice Nozzle
For corners,cracks etc.



HEPA Filter



Plastic Connection Parts

Mixer Station with Timer

- ▲ Easy Transport with 2 big wheels
- ▲ Thermal protection prevents motor overload.
- ▲ Three pieces design for easy storage or transportation
- ▲ Power 750W
- ▲ Voltage 230V-50HZ
- ▲ Tub volume 65 litres
- ▲ Maximum mixing capacity 50Kg



20L Bucket Liner

- ▲ Soft and durable material
- ▲ Easy to clean and can be used multiple times
- ▲ Suitable for 20L mixing bucket

Art.No	Size
MPBL20	250(-270mm)x370mm 10"(-10-1/4")x14-3/4"



Portable Mortar Mixer

- ▲ Powerful mixer with a compact and robust design
- ▲ Removable paddles for easy cleaning
- ▲ Drum capacity 120L, 100L mixing capacity
- ▲ Socket opener on the lid for easier filling
- ▲ Suitable for mixing a variety of substances including cement, mortar, plaster and concrete

Technical Data	
Art.No	MM1500
Power	1500W
Voltage	230V
Frequency	50HZ
Motor Power	1600RPM
Drum Capacity	120L(32Gal)
Drum Mouth Diameter	690mm(27.17")
Drum Rotate Speed	30RPM
Loading	120kgs(264.56lbs)
Overall Dimensions	760x820x1170mm(27"x32"x46")
Net Weight	127kgs(280lbs)

Manufacturer reserves the right to change specifications without notice. Specifications may differ from country to country

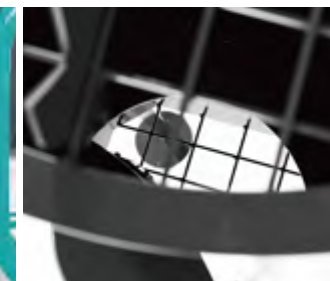



Leveling Compound Mixing Station

- ▲ Mixes up to 100kg with hands free
- ▲ Ergonomic handle and damping structure angles for pouring
- ▲ Removable 1900W mixing machine and large paddle
- ▲ Brake transporting castors and light weight frame
- ▲ Arc-shaped pouring spout and dust cover plate
- ▲ Suitable for mixing self-levelling cement, compounds & epoxies with good fluidity

Technical Data	
Art.No	MS1900
Measurement	745x560x997mm
Net Weight	33.5Kg
Power	1900W
Voltage/Frequency	230V/50-60HZ
No load speed	1st 150-300RPM 2nd 300-650RPM
Mixing Paddle	300x600mm
Capacity	100L
Noise measurements	LpA=85,8dB(A)
LpA [dB(A)]	LpA =85,8dB(A)
LpCpeak (dB)	Less than 130dB(A)
KpCpeak (dB)	
Lwa [dB(A)]	LwA =96,8dB(A)
Kwa [dB(A)]	Kwa=3 dB(A)
Work mode - vibration emission value a (m/s ²)	ah,D=1,695m/s ²
Uncertainty K (m/s ³)	K= 1,5 m/s ²

Manufacturer reserves the right to change specifications without notice.
Specifications may differ from country to country



Leveling Compound Mixing Station

- ▲ Hands-free mixing up to 220lbs
- ▲ Ergonomic handle and damping structure angles for easy pouring
- ▲ Removable 1800W mixing machine and large paddle
- ▲ Brake transporting castors and lightweight frame
- ▲ Arc-shaped pouring spout and dust cover plate
- ▲ Suitable for mixing self-leveling cement, compounds & epoxies with good fluidity

Technical Data	
Art.No	MS1900A
Measurement	29" x 22" x 39"
Net Weight	73.85 lbs
Power	1800W
Voltage/Frequency	110V/560HZ
No load speed	1st 150-300RPM 2nd 300-650RPM
Mixing Paddle	11-3/4" x 24"
Capacity	100L(26Gal)
Noise measurements	LpA=85,8dB(A)
LpA [dB(A)]	LpA =85,8dB(A)
LpCpeak (dB)	Less than 130dB(A)
KpCpeak (dB)	
Lwa [dB(A)]	LwA =96,8dB(A)
Kwa [dB(A)]	Kwa=3 dB(A)
Work mode - vibration emission value a (m/s ²)	ah,D=1,695m/s ²
Uncertainty K (m/s ³)	K= 1,5 m/s ²

Manufacturer reserves the right to change specifications without notice.
Specifications may differ from country to country



15°



45°



90°

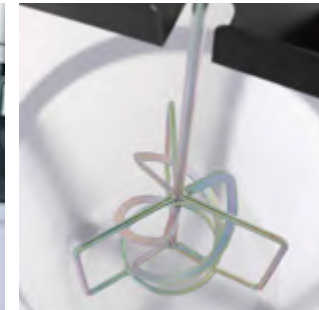



Battery Handheld Mixer

- ▲ Variable and constant speed
- ▲ VDE plug and 3M cable
- ▲ Quick assembly mixing paddle
- ▲ Electronic soft start function
- ▲ FFU device
- ▲ Suitable for mixing cement, paints, tile adhesive, glue etc.

Technical Data			
	1600W	1800W	2000W
Mixing volume	65 litres	85 litres	85 litres
Mixing paddle	600x140mm	600x160mm	600x160mm
Rated voltage	230/110V		
Frequency	50/60HZ		
Speed I	250-500RPM		
Speed II	400-800RPM		
Thread size	M14		
Protection	Class II		

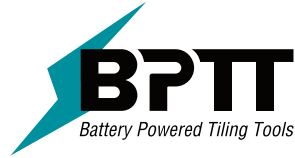

Electric Handheld Mixer 1800W

- ▲ Paddle designed for fast and effective mixing of viscous materials
- ▲ Lightweight, impact-resistant motor housing
- ▲ High-torque for powerful mixing
- ▲ Variable speed with soft startup
- ▲ Ergonomic handle helps reduce fatigue
- ▲ VDE plug and 3m(118") cable
- ▲ Indicator light for overload & carbon brush changing alert
- ▲ Suitable for mixing cement, paints, tile adhesive, glue etc.

Technical Data	
Art.No	MMA1800
Output	1800W
Voltage	110V/60Hz
Speed	200-480RPM / 300-750RPM
Fitting	M14
Paddle	140 x 600mm(5.5"x24")
Mixture Volume	120L(32Gal)
LpA	97 dB(A)
LwA	108 dB(A)
aw(Vibration)	5.5m/s2 K=1.5m/s2
Protection class II	



Electric Handheld Mixer

- ▲ Variable and constant speed
- ▲ VDE plug and 3m(118") cable
- ▲ Quick assembly mixing paddle
- ▲ Electronic soft start function
- ▲ FFU device
- ▲ Suitable for mixing cement, paints, tile adhesive, glue etc.

Technical Data			
Art.No	MMB1600	MMB1800	MMB2000
	1600W	1800W	2000W
Mixing volume	17 Gal	22 Gal	22 Gal
Mixing paddle	24"x5-1/2"	24"x6-3/8"	24"x6-3/8"
Rated voltage	230/110V		
Frequency	50/60HZ		
Speed I	250-500RPM		
Speed II	400-800RPM		
Thread size	M14		
Protection	Class II		



Electric Handheld Mixer 1200W

- ▲ Heavy duty gear system with large torque
- ▲ With 300 hours continued working time
- ▲ Paddle swing < 0.5mm without fatigue
- ▲ Maximum mixture loading 40L
- ▲ Suitable for mixing cement, paints, tile adhesive, glue etc

Technical Data	
Art.No	MME1200
Output	1200W
Voltage	230V/50Hz
Speed	150-300RPM / 300-650RPM
Fitting	M14
Paddle	120 x 600mm
Protection	class II



Soft start and constant speed



Six speed for choosing

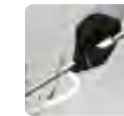

Quick installing mixing paddle





Twist Mixing Paddle

- ▲ M14 steel handle with metal hanger
- ▲ Suitable for mortar, tile adhesive, plaster, screed and filling compounds

Art.No	Size	
MPGZ120	120xM14 x600mm	4-3/4"x5/8"-11x24"
MPGZ600	140xM14 x600mm	5-1/2"x5/8"-11x24")
MPGZ160	160xM14 x600mm	6-3/8"x5/8"-11x24"



Spiral Mixing Paddle

- ▲ M14 steel handle with metal hanger
- ▲ Suitable for mortar, tile adhesive, plaster, screed and filling compounds

Art.No	Size	
MPSC120	120xM14 x600mm	4-3/4"x5/8"-11x24"
MPSC600	140xM14 x600mm	5-1/2"x5/8"-11x24")
MPSC160	160xM14 x600mm	6-3/8"x5/8"-11x24"



Paint Mixing Paddle

- ▲ Hexagon shaft to fit drill machine
- ▲ Powder coating
- ▲ Suitable for mixing mud and paint

Art.No	Size	
MPPS400	80x8x400mm	3-9/64"x5/16"-15-3/4"



Box Mixing Paddle

- ▲ Hexagon shaft to fit drill machine
- ▲ Spraying coating treatment
- ▲ Suitable for mixing mortar, tile adhesive, plaster, screed and filling compounds

Art.No	Size	
MPD760	130x10x860mm	5-1/8"x3/8"-33-1/2"



Twist Mixing Paddle

- ▲ Quick change design for BIHUI adaptor
- ▲ M14 steel handle with metal hanger
- ▲ Suitable for mortar, tile adhesive, plaster, screed and filling compounds

Art.No	Size	
MMB-MP01	120xM14 x600mm	4-3/4"x5/8"-11x24"

Spiral Mixing Paddle

- ▲ Quick change design for BIHUI adaptor
- ▲ M14 steel handle with metal hanger
- ▲ Suitable for mortar, tile adhesive, plaster, screed and filling compounds

Art.No	Size	
MMB-MP02	120xM14 x600mm	4-3/4"x5/8"-11x24"

Quick Change Adaptor

- ▲ M14 Thread to Fit with Most Machine
- ▲ Quick change design with a clamp
- ▲ For use with BIHUI quick change mixing paddle

Art.No	Size	
MMBADP	80x8x400mm	3-9/64"x5/16"-15-3/4"



Handheld Drill & Mixer

- ▲ 1/2"-13mm-M14 thread
- ▲ Forward/reverse switch
- ▲ Rear D-handle rotates 360°
- ▲ Variable speed trigger with Lock-on button for continuous operation
- ▲ Suitable for mixing and drilling
- ▲ UL plug

Technical Data	
Art.No	MMD1214
Output	1800W
Voltage	110V/60Hz
Speed	200-480RPM / 300-750RPM
Fitting	M14
Paddle	140 x 600mm(5,5"x24")
Protection class II	



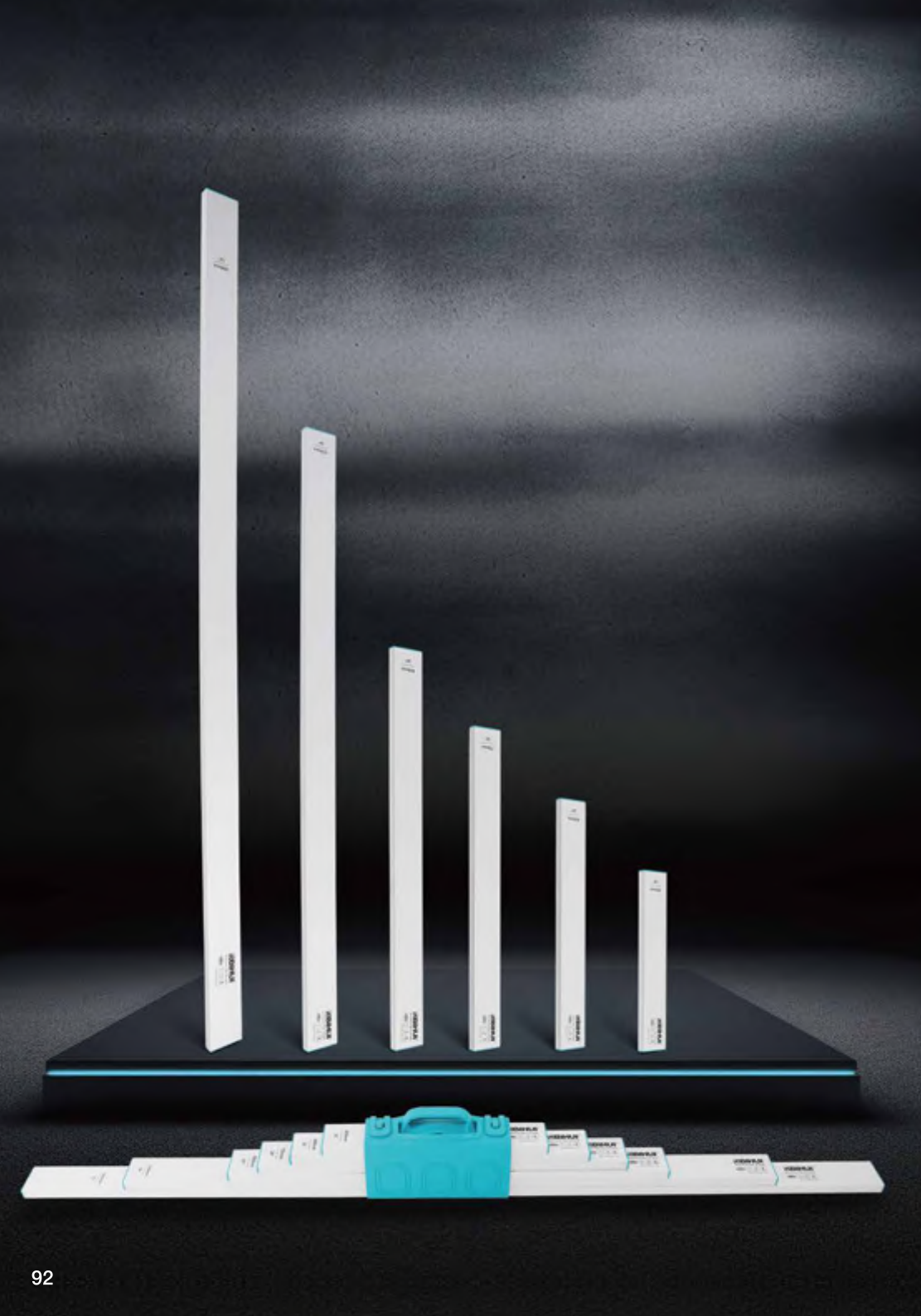

Aluminum Box Screed Set

- ▲ Straight edges with BIHUI protection ends
- ▲ Accuracy: $\pm 0.05\text{mm/m}$ (0.0002in/in)
- ▲ Features a heavy duty rectangular construction which provides exceptional straightest, strength and light weight
- ▲ Clear anodized aluminum construction guarantees it will not rust, rot or warp and easy to clean
- ▲ Used for leveling material in concrete paving and landscape work

Art.No	Size
TASES6	450mm(18"), 600mm(24"), 750mm(30"), 900mm(36"), 1350mm(54"), 1800mm(72")





16 Lines Laser Level

- ▲ Lithium-ion battery powered
- ▲ OSRAM green beams
- ▲ 360° self-levelling
- ▲ Equipped with TFT color screen display
- ▲ Accurate reset function and self-levelling automatically
- ▲ Built-in memory function
- ▲ Supports tilting at any angle, patented technology
- ▲ Three levels of brightness adjustable
- ▲ Perfect for auxiliary levelling in multiple occasions
- ▲ Continuous working - 5 hours
- ▲ Full charging - 4 hours



Accessories includes:
 USB charging
 Lithium-ion Battery
 Laser target plate
 Green glasses
 Lifting platform

Art.No	Data
LLG16	3.7V-5.0Ah



12 Lines Laser Level

- ▲ Auxiliary tiles fixing, wall decoration, floor tiles fixing, stair handrails, furred ceiling, floor tile, plastering etc
- ▲ Lithium-ion battery powered
- ▲ OSRAM green beams
- ▲ 360° self-levelling
- ▲ Adjusting bracket with level spirit
- ▲ Magnetic backing bracket and extra adjuster
- ▲ Green glasses and target plate
- ▲ Perfect for auxiliary levelling in multiple occasions

Accessories includes:
 USB charging
 Lithium-ion Battery
 Laser target plate
 Green glasses
 Bracket with adjusting and level spirit
 Magnetic bracket PV9 & PV6+

Art.No	Data
LLG12	3.7V - 5.2Ah

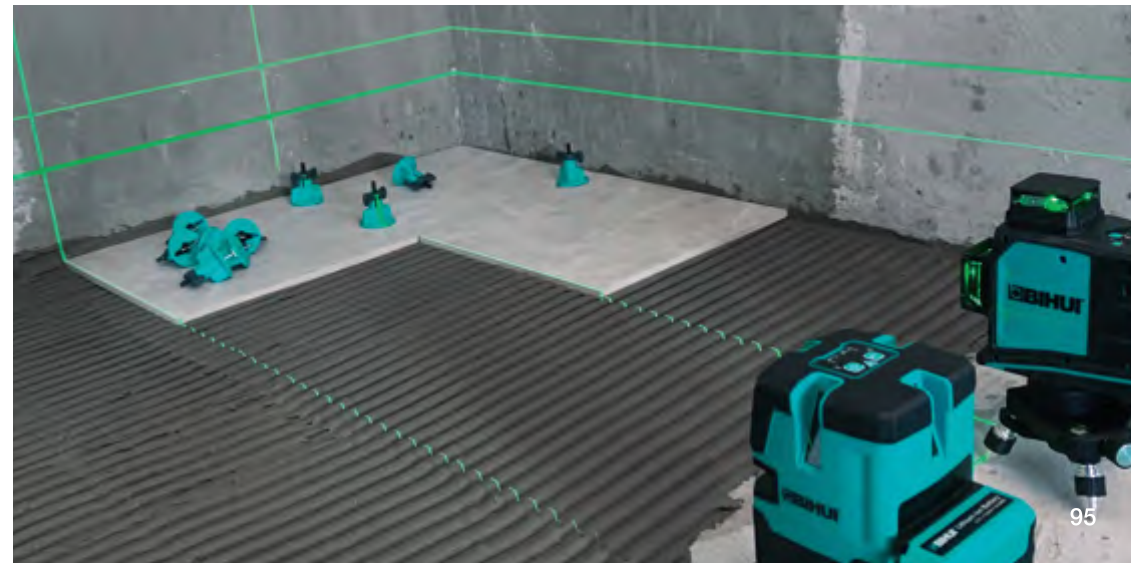

5 Lines Laser Level

- ▲ Auxiliary tiles fixing, wall decoration, floor tiles fixing, stair handrails, furred ceiling, floor tile, plastering etc
 - ▲ Lithium-ion battery powered
 - ▲ OSRAM green beams
 - ▲ 360° self-levelling
 - ▲ Adjusting bracket with level spirit
 - ▲ Green glasses and target plate
 - ▲ Perfect for auxiliary levelling in multiple occasions
- Accessories includes:**
 USB charging
 Lithium-ion Battery
 Laser target plate
 Green glasses
 Bracket with adjusting and level spirit

Art.No	Data	Data
LLG05	3.7V	5.2Ah



Tripod for Laser Level

- ▲ Foldable tripod with 5/8"-11 connection
- ▲ Extra 5/8"-11 to M14 adaptor
- ▲ Adjustable height up to 1,5M
- ▲ Perfect for BIHUI laser levels

Art.No	Size
LLG-TRP	58-150cm (2-1/4")-(6")

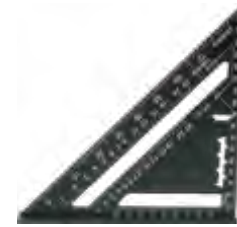

Speed Triangle Square

- ▲ Strong aluminium alloy body
- ▲ Embossed imperial graduations and common rafter conversion table
- ▲ Features a protractor scale 0-90°
- ▲ Use as saw guide for angle measurements and cuts
- ▲ Ideal for all building and remodeling projects

Art.No	Size
TMRT7	180mm 7"



Long Tape Measure

- ▲ Waterproof fiberglass ruler
- ▲ 3 times retracting speed
- ▲ Tape in 15mm width and thickness 0.48mm
- ▲ Level 3 accuracy

Art.No	Size
TMR30M	30M 100"



Wide Blade Tape Measure

- ▲ Wear and impact-resistant with nylon bond
- ▲ Equipped with a powerful magnetic ruler head
- ▲ Automatic brake and one button to retract
- ▲ Comes with back clip

Art.No	Size	Blade info.
TMR5M	65x60x30mm (2-1/2"x2-3/8"x1-3/16")	5M(16') 22mm-1.9M
TMR8M	80x75x35mm (2-1/2"x2-3/8"x1-3/16")	8M(26') 27mm-2.8M



Blue Chalk Powder

- ▲ For use with chalk line reels
- ▲ Designed with handy nozzle cap and squeeze bottles
- ▲ Meets the basic requirement of RoHS and REACH
- ▲ Suitable for both interior and exterior use

Art.No	Size
CTCHALK	8OZ



Chalk Line Reel

- ▲ Quick refilling sliding window
- ▲ Press to release mechanism
- ▲ High strength thread and faster retraction
- ▲ For use with BIHUI Chalk Powder
- ▲ Powder capacity: 100 grams
- ▲ Break strength: 20kg

Art.No	Size
CTCKLNR	30Mx Ø1mm



Chalk Reel Kit

- ▲ Blue Chalk Powder with chalk line reels
- ▲ Meets the basic requirement of RoHS and REACH
- ▲ High strength thread and faster retraction
- ▲ Suitable for both interior and exterior use

Art.No	Size
CTCAKK2	30Mx Ø1mm, 8OZ

B-RolleX



Tile Spirit Level

- ▲ Accuracy : 0.5mm/m (0.0005in/in)
- ▲ Finely milled surface for higher accuracy
- ▲ Shock proof rubber end caps
- ▲ Comfortable rubber handle
- ▲ Magnified horizontal vial for clearest view of the bubble
- ▲ 3 Solid acrylic shockproof vials to check horizontal, vertical levels

Art.No	Size	
TSL060	60cm	24"
TSL080	80cm	32"
TSL100	100cm	40"
TSL120	120cm	47-1/4"
TSL180	180cm	71"
TSL240	240cm	96"

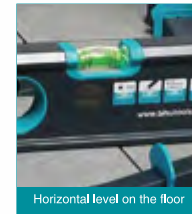

Horizontal level on the floor



Vertical level on the wall



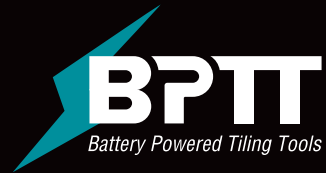

BIHUI Battery Powered Tiling Tools
is ready to hit the market.



Electric Vacuum Suction Cup

- ▲ Max. lifting capacity: 170Kg(375lbs)
- ▲ Powered by 21V lithium-ion battery
- ▲ Digital gauge showing pressure
- ▲ Smart sensor monitor maintains optimum suction
- ▲ Double layer pad for smooth surfaces
- ▲ Additional pad specifically for textured items
- ▲ Continuous working - 3 hours
- ▲ Full charging - 2.5 hours

Art.No	Max. Lifting Capacity
LFBSL	170Kg(375lbs)
LFBSL-RUB	Pad for smooth surfaces
LFBSL-TXP	Pad for texture surfaces
BP21-BAT2.0	Lithium-ion battery 21V-2.0Ah



Operation Instructions:



Position the GRABO® to the flat material surface you want to carry

Slide the power switch ON

Press green button when ready

Lift GRABO® handle to carry with ease

Press red button to release

Smart digital pressure sensor



Electric Cordless Vacuum Suction Cup

- ▲ Smart digital pressure sensor
- ▲ The portable, electric battery vacuum suction lifter holds securely and firmly on almost any surface
- ▲ Extremely high suction power (up to max. 170 kg)
- ▲ Perfect for large formats, natural stone, thick terrace slabs, etc.
- ▲ Securely hold even on heavily structured, porous and damp surfaces
- ▲ Continuous working for 1.5hours
- ▲ Charging time for 2 hours

Includes:

- 1 x 4in1 charger(USA,AU,EU,UK)
- 2 x Filter felt
- 1 x User's manual
- 1 x Tool bag

Art.No	Description	Data
LFEVC	V1 with 2 batteries and 2 sealing ring	14.8V - 2.6Ah

LVT Battery Suction Cup

- ▲ Perfect for LVT floor laying
- ▲ Automatic air replenishment mechanism
- ▲ Feature with digital display
- ▲ Steel plate design for gap adjustment and lifting
- ▲ Dual rubber pad guarantee superior sealing
- ▲ Suitable for both smooth and texture surface



NEW



Optional

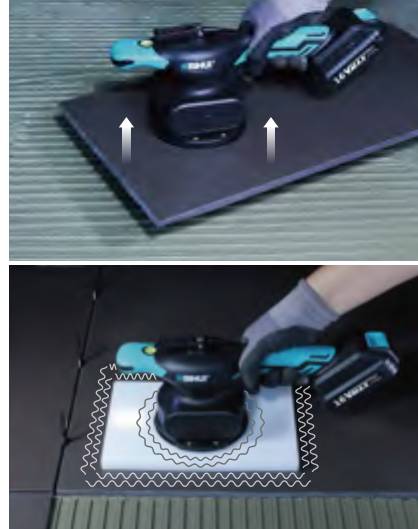

CVT Vibration Tile Beater

- ▲ Continuously variable transmission speed
- ▲ Powered with lithium-ion battery
- ▲ TPR grip handle for maximum comfort
- ▲ Suction cup with 35kg lifting capacity
- ▲ Designed with spirit level bubble and working light
- ▲ Evenly distribute the adhesive under tiles and big slabs during installation



Art.No	Description	Data
LFTBU	Include 2 batteries	16V - 2Ah
LFTBV	Include 1 battery	16V - 2Ah
LFTBV-BAT	Battery	16V - 2Ah

Square Beating Block

- ▲ With 130x7mm opening in the middle
- ▲ Suitable for most suction cups
- ▲ For largely spread the vibration to the tiles
- ▲ Overall size 260x180x12mm



Art.No	Description	Data
LFTBV-BB	Tile Beating Block	Hole 130x7mm

3 in 1 Charger



Art.No	Description	Data
LFTBA-CG	3in1 charger(USA,UK,EU)	21V - 1A
LFTBV-CG31	3in1 charger(USA,UK,EU)	16V - 1.4A

Spare Suction Pad

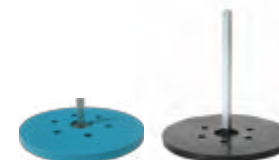

Art.No	Description	Data
LFTBA-RB	Spare Suction Pad	118mm
LFTBV-RB	Spare Suction Pad	128mm



Vibration Tile Beater

- ▲ Powered with 21V lithium-ion battery
- ▲ Eco grip handle for maximum comfort
- ▲ Suction cup with 35kg lifting capacity
- ▲ Designed with digital control panel with 6 speeds
- ▲ Evenly distribute the adhesive under tiles and big slabs during installation

Art.No	Description	Data
LFTBA-Plus	Include 2 batteries	21V - 2Ah
LFTBA	Include 1 battery	21V - 2Ah
LFTBA-BAT	Battery	21V - 2Ah



CVT 2.0



Smart Vibration Tile Beater

- ▲ Powered with BIHUI lithium-ion battery
- ▲ Continuously variable transmission speed
- ▲ Anti-vibration auxiliary handle and TPR grip handle for max.comfort
- ▲ Designed with spirit level bubble and large fixing clamp
- ▲ Suction cup with 35kg(77lbs) lifting capacity
- ▲ Evenly distribute the adhesive under tiles and big slabs during installation

Art.No	Description	Data
LFTBS-Plus	Include 2 batteries	21V - 2Ah
LFTBS	Include 1 battery	21V - 2Ah
BP21-BAT2.0	Battery	21V - 2Ah

SUCTION CUP



Electric Battery Pump

- ▲ Working indicator button
- ▲ USB charger 30cm / AC/DC charging box

Art.No	Size	Data
SCBB8-PG	Ø36mmx169mm (1-55/27"x7")	3.7V / 2000mA



8" Vacuum Suction Cup

- ▲ With Pressure Monitor
- ▲ Lifting capacity 110Kg (243lbs)
- ▲ Anti-slip soft grip handle
- ▲ Durable structure and light weight
- ▲ Quick release lever & comfort pump action
- ▲ **Suitable for both smooth and texture surface**
- ▲ Ideal for large porcelain or stone, tiles and glass

Art.No	Size
SCVB8	200mm 8"



Electric Battery Pump

- ▲ Working indicator button
- ▲ USB charger 30cm / AC/DC charging box

Art.No	Size	Data
SCBS8-PG	Ø35mmx172mm (1-3/8"x7")	3.7V / 1200mAh



Battery Vacuum Suction Cup

- ▲ Lifting capacity 130Kg (286lbs)
- ▲ Automatical air replenishment mechanism guards safety carrying
- ▲ Feature with double monitoring system,digital display and pressure gauge
- ▲ Dual rubber and extra rubber ring guarantee superior sealing
- ▲ Large Lithium battery 21700, 4000mAh works longer
- ▲ Suitable for both smooth and texture surface

Art.No	Size
SCBA8	200mm 8"



8" Battery Vacuum Suction Cup Kit

- ▲ Featured with spare electric battery plunger
- ▲ Manual pump and electric pump action
- ▲ Manual lifting capacity 110Kg(243lbs)
- ▲ Electric lifting capacity 140Kg(309lbs)
- ▲ Anti-slip plastic handle
- ▲ Suitable for both smooth and **texture surface**
- ▲ Packed in BMC box

Art.No	Size
SCBB8	200mm 8"



Battery Vacuum Suction Cup

- ▲ Automatical air replenishment mechanism guards safety carrying
- ▲ Feature with double monitoring system,digital display and pressure gauge
- ▲ Dual rubber and extra rubber ring guarantee superior sealing
- ▲ Large Lithium battery 26500, 3200Ah works longer
- ▲ Suitable for both smooth and texture surface
- ▲ Suction cup for handling large and heavy tiles

Art.No	Size
SCBC8	200mm 8"



8" Battery Vacuum Suction Cup Kit

- ▲ Featured with spare electric battery plunger
- ▲ Manual pump and electric pump action
- ▲ Manual lifting capacity 110Kg(243lbs)
- ▲ Electric lifting capacity 140Kg(309lbs)
- ▲ Anti-slip plastic handle
- ▲ Suitable for both smooth and **texture surface**
- ▲ Packed in BMC box

Art.No	Size
SCBS8	200mm 8"



8" Vacuum Suction Cup

- ▲ Lifting capacity 110Kg (243lbs)
- ▲ Anti-slip plastic handle
- ▲ Pump action & quick release lever
- ▲ **Suitable for both smooth and texture surface**

Art.No	Size
SCVU8	200mm 8"



Use Instruction



Press to start absorbing



Automatically replenish air



Press twice to release



USB charger

SUCTION CUP

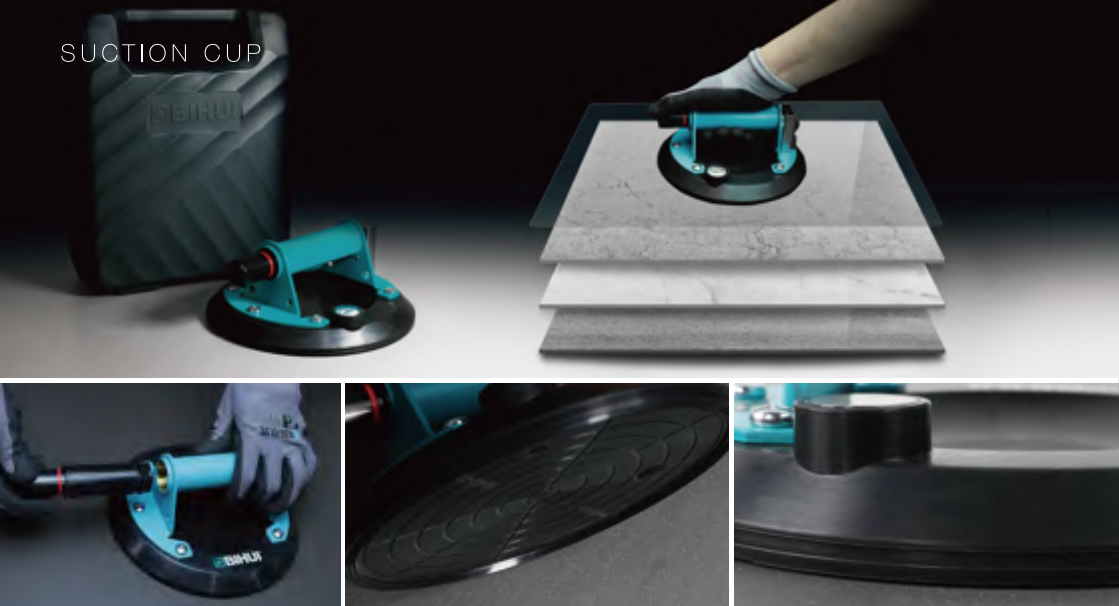

6" Vacuum Suction Cup

- ▲ Lifting capacity 100Kg (220lbs)
- ▲ Durable multi-level rubber
- ▲ Heavy duty steel handle & brass tube
- ▲ Pump action & quick release lever
- ▲ Ideal for large porcelain or stone, tiles and glass



Art.No	Size		Art.No	Size	
SCVM6	150mm	6"	SCVG6	150mm	6"

8" Vacuum Suction Cup

- ▲ Lifting capacity 120Kg (265lbs)
- ▲ Durable multi-level rubber
- ▲ Heavy duty steel handle & brass tube
- ▲ Pump action & quick release lever
- ▲ Ideal for large porcelain or stone, tiles and glass



Art.No	Size		Art.No	Size	
SCVM8	200mm	8"	SCVG8	200mm	8"

Mega Suction Cup

- ▲ Lifting capacity: 40kg (88lbs)
- ▲ Made of aluminium with rubber suction cup
- ▲ Jumbo ergonomic comfort handle
- ▲ Ideal of carrying ceramic tiles, marble and glass

Art.No	Size	
SCSB4	122mm	4.8"



Mega Double Suction Cup

- ▲ Lifting capacity: 85kg (187lbs)
- ▲ Made of aluminium with rubber suction cup
- ▲ Jumbo ergonomic handle and comfort fixing buttons
- ▲ Ideal of carrying ceramic tiles, marble and glass

Art.No	Size	
SCDB4	125mm	5"



Mega Triple Suction Cup

- ▲ Lifting capacity: 110kg (243lbs)
- ▲ Made of aluminium with rubber suction cup
- ▲ Jumbo ergonomic handle and comfort fixing buttons
- ▲ Ideal of carrying ceramic tiles, marble and glass

Art.No	Size	
SCTB4	125mm	5"



WORLD'S FIRST

All-in-one Reusable Tile Leveling System



**INTERNATIONAL
PATENTED**



Reusable Tile Leveling System

- ▲ Holds tile level & eliminates lippage
- ▲ Ideal for walls and floors tiles up to 17mm
- ▲ Suitable for tile clearance 1,5-6 mm
- ▲ Used in conjunction with other levelling systems or spacers
- ▲ Anti-scratching large cap and fast spin-down handle
- ▲ Reusable and all in one, saves both time and money

Art.No	Size		Qty
TSL50	1,5mm	1/16"	50pcs
TSL250	1,5mm	1/16"	250pcs
TSL50-SN	T spin nails		50pcs



HOW TO USE



1 Insert T-pin parallel into the grout joint
(For a wider joint, use classic spacers together)

2 Hold the blue cap in 90° position and spin down the gray handle

3 Twist the gray handle down to the required level
(no tools needed)

4 Return parallelly back for 90° to the grout joint for reuse
(Note: remove immediately after the grout has cured, referring to the manufacturer's instruction, no more than 6 hours.)

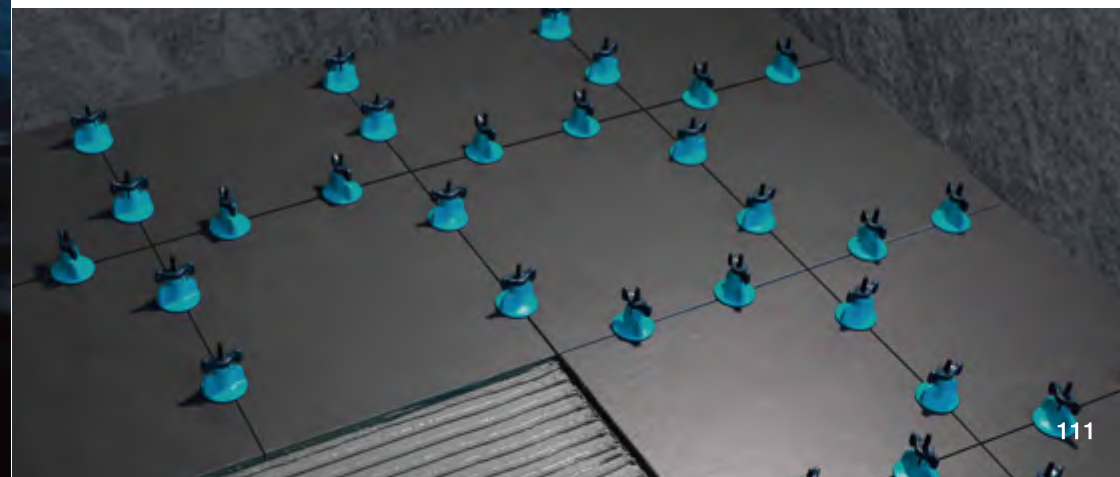

B-RIGID

LEVEL SYSTEM

PATENTED



Tile Leveling Spacer

- ▲ Holds tiles level
- ▲ Ideal for walls & floors
- ▲ Eliminates lippage on uneven tiles

Art.No	Size	Qty
BLSS100	0.5mm(1/64")	100pcs
BLSS250	0.5mm(1/64")	250pcs
BLSS500	0.5mm(1/64")	500pcs
BLSS1K	0.5mm(1/64")	1000pcs
BLSS2K	0.5mm(1/64")	2000pcs



Tile Leveling Spacer

- ▲ Holds tiles level
- ▲ Ideal for walls & floors
- ▲ Eliminates lippage on uneven tiles

Art.No	Size	Qty
BLS1100	1mm(1/32")	100pcs
BLS1250	1mm(1/32")	250pcs
BLS1500	1mm(1/32")	500pcs
BLS11K	1mm(1/32")	1000pcs
BLS12K	1mm(1/32")	2000pcs



Tile Leveling Spacer

- ▲ Holds tiles level
- ▲ Ideal for walls & floors
- ▲ Eliminates lippage on uneven tiles

Art.No	Size	Qty
BLS2100	1.5mm(1/16")	100pcs
BLS2250	1.5mm(1/16")	250pcs
BLS2500	1.5mm(1/16")	500pcs
BLS21K	1.5mm(1/16")	1000pcs
BLS22K	1.5mm(1/16")	2000pcs



Tile Leveling Spacer

- ▲ Holds tiles level
- ▲ Ideal for walls & floors
- ▲ Eliminates lippage on uneven tiles

Art.No	Size	Qty
BLSN100	2mm(5/64")	100pcs
BLSN250	2mm(5/64")	250pcs
BLSN500	2mm(5/64")	500pcs
BLSN1K	2mm(5/64")	1000pcs
BLSN2K	2mm(5/64")	2000pcs



Tile Leveling Spacer

- ▲ Holds tiles level
- ▲ Ideal for walls & floors
- ▲ Eliminates lippage on uneven tiles

Art.No	Size	Qty
BLS3100	3mm(1/8")	100pcs
BLS3250	3mm(1/8")	250pcs
BLS3500	3mm(1/8")	500pcs
BLS31K	3mm(1/8")	1000pcs
BLS32K	3mm(1/8")	2000pcs



Tile Leveling Wedge

- ▲ Eliminates lippage on uneven tiles
- ▲ Spacer function for 1/32", 5/64", 1/8" and 0.059"
- ▲ Used for .1" - .8" tile

Art.No	Size
BLSE100	4"x7/8"x1-1/16"
BLSE250	
BLSE500	
BLSE1K	



Tile Leveling Plier

- ▲ Improved accuracy and installation speed
- ▲ Fast adjustable space mechanic
- ▲ Ergonomic comfort handle
- ▲ Maximum working depth 1/2"
- ▲ Ideal for walls and floors

Art.No	Size
BLSFP	Universal



Tile Leveling Kit

- ▲ 1x Floor and wall plier
- ▲ 100x Tile level wedge
- ▲ 100x Tile level spacer

Art.No	Size
BLSK1	1mm(1/32")
BLSK2	1.5mm(1/16")
BLSK3	3mm(1/8")

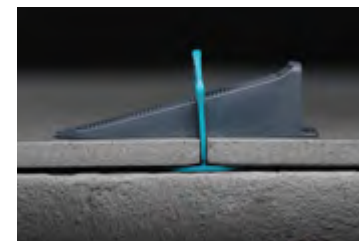

LEVELING SYSTEM



3 tubes to be connect together



Levelling System Removal Roller

- ▲ High quality and smooth nylon wheels
- ▲ Chamfer design to prevent tiles from scratching
- ▲ Ergonomic handle and 1.35M length for standing working
- ▲ Triple efficient for removing all types of tile leveling system

Art.No	Size
BLSRR	1.4M 55"

HOW TO USE

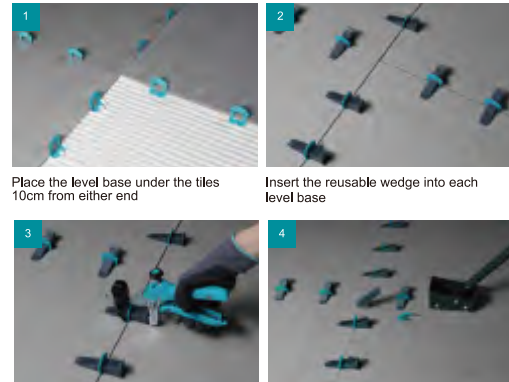

1 Place the level base under the tiles 10cm from either end

2 Insert the reusable wedge into each level base

3 Use the plier to tighten to the required level

4 Remove the wedge with BIHUI levelling dozer for reuse

COVERAGE

inch

	6	9	12	16	18	20	24	30	32	36	40	48	60	72	80	96	120	144		
6	5	5.3	6	4.5	4	3.6	3	3.2	3	2.7	2.4	2	2	1.7	1.8	1.5	1.4	1.5	1.3	6
9	5	5	4.6	4.0	3.0	2.7	2.4	2.0	2.1	2.0	1.8	1.5	1.3	1.1	1.2	1.0	0.9	1.0	0.9	9
12	5	4.6	4	3	2.7	2.4	2	2	1.9	1.7	1.5	1.3	1.2	1	1.1	0.9	0.8	0.8	0.8	12
16	5	4.4	3.3	2.3	2	1.8	1.5	1.4	1.3	1.1	0.9	0.8	0.8	0.7	0.6	0.6	0.6	0.6	0.6	16
18	5	4.3	3.2	2.2	1.8	1.5	1.3	1.2	1.1	0.9	0.8	0.7	0.7	0.6	0.5	0.5	0.5	0.5	0.5	18
20	5	4.2	3.1	2.1	1.7	1.4	1.2	1.1	1	0.8	0.7	0.6	0.6	0.5	0.4	0.4	0.4	0.4	0.4	20
24	5	4	2.9	1.9	1.6	1.4	1.2	1.1	1	0.8	0.7	0.6	0.5	0.4	0.4	0.4	0.4	0.4	0.4	24
30	5	3.8	2.7	1.7	1.5	1.3	1.1	1	0.9	0.8	0.7	0.6	0.5	0.4	0.4	0.4	0.4	0.4	0.4	30
32	5	3.7	2.6	1.6	1.4	1.2	1.1	1	0.9	0.8	0.7	0.6	0.5	0.4	0.4	0.4	0.4	0.4	0.4	32
36	5	3.6	2.5	1.5	1.3	1.1	1	0.9	0.8	0.7	0.6	0.5	0.4	0.4	0.4	0.4	0.4	0.4	0.4	36
40	5	3.5	2.4	1.4	1.2	1.1	1	0.9	0.8	0.7	0.6	0.5	0.4	0.4	0.4	0.4	0.4	0.4	0.4	40
48	5	3.3	2.2	1.3	1.1	1	0.9	0.8	0.7	0.6	0.5	0.4	0.4	0.4	0.4	0.4	0.4	0.4	0.4	48
60	5	3.1	2	1.1	1	0.9	0.8	0.7	0.6	0.5	0.4	0.4	0.4	0.4	0.4	0.4	0.4	0.4	0.4	60
72	5	2.9	1.9	1	0.9	0.8	0.7	0.6	0.5	0.4	0.4	0.4	0.4	0.4	0.4	0.4	0.4	0.4	0.4	72
80	5	2.8	1.8	0.9	0.8	0.7	0.6	0.5	0.4	0.4	0.4	0.4	0.4	0.4	0.4	0.4	0.4	0.4	0.4	80
96	5	2.6	1.6	0.8	0.7	0.6	0.5	0.4	0.4	0.4	0.4	0.4	0.4	0.4	0.4	0.4	0.4	0.4	0.4	96
120	5	2.4	1.4	0.7	0.6	0.5	0.4	0.4	0.4	0.4	0.4	0.4	0.4	0.4	0.4	0.4	0.4	0.4	0.4	120
144	5	2.2	1.2	0.6	0.5	0.4	0.4	0.4	0.4	0.4	0.4	0.4	0.4	0.4	0.4	0.4	0.4	0.4	0.4	144
180	5	2	1	0.5	0.4	0.3	0.3	0.3	0.3	0.3	0.3	0.3	0.3	0.3	0.3	0.3	0.3	0.3	0.3	180
200	5	1.9	0.9	0.4	0.3	0.3	0.3	0.3	0.3	0.3	0.3	0.3	0.3	0.3	0.3	0.3	0.3	0.3	0.3	200
240	5	1.7	0.7	0.3	0.3	0.3	0.3	0.3	0.3	0.3	0.3	0.3	0.3	0.3	0.3	0.3	0.3	0.3	0.3	240
300	5	1.5	0.5	0.2	0.2	0.2	0.2	0.2	0.2	0.2	0.2	0.2	0.2	0.2	0.2	0.2	0.2	0.2	0.2	300
320	5	1.4	0.4	0.2	0.2	0.2	0.2	0.2	0.2	0.2	0.2	0.2	0.2	0.2	0.2	0.2	0.2	0.2	0.2	320
360	5	1.3	0.3	0.1	0.1	0.1	0.1	0.1	0.1	0.1	0.1	0.1	0.1	0.1	0.1	0.1	0.1	0.1	0.1	360

cm

HOW TO USE

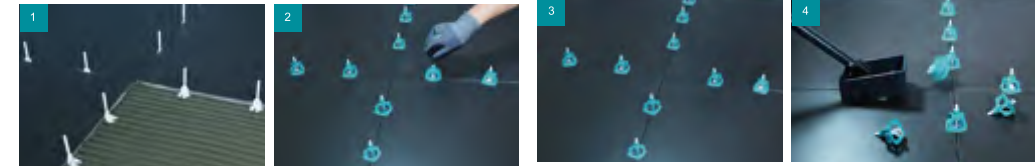

1 Place the level base under the tiles 10 cm from either end

2 Apply the level washer and level cap to the level base

3 Spin down the level cap to the required level to ensure no lippage

4 Remove the cap with BIHUI levelling dozer for reuse

Spin Level Base 1mm

- ▲ Holds tiles level up to 18mm
- ▲ Ideal for walls & floors
- ▲ Eliminates lippage on uneven tiles

Art.No	Size	Qty
SL1100	1mm(1/32")	100pcs
SL1500	1mm(1/32")	500pcs
SL11K	1mm(1/32")	1000pcs

Spin Level Base 1.5mm

- ▲ Holds tiles level up to 18mm
- ▲ Ideal for walls & floors
- ▲ Eliminates lippage on uneven tiles

Art.No	Size	Qty
SL2100	1.5mm(1/16")	100pcs
SL2500	1.5mm(1/16")	500pcs
SL21K	1.5mm(1/16")	1000pcs

Spin Level Base 3mm

- ▲ Holds tiles level up to 18mm
- ▲ Ideal for walls & floors
- ▲ Eliminates lippage on uneven tiles

Art.No	Size	Qty
SL3100	3mm(1/8")	100pcs
SL3500	3mm(1/8")	500pcs
SL31K	3mm(1/8")	1000pcs

Spin Level Base Higher

- ▲ Holds tiles level up to 35mm
- ▲ Ideal for walls & floors
- ▲ Eliminates lippage on uneven tiles

Art.No	Size	Qty
SL3H100	3mm(1/8")	100pcs
SL3H500	3mm(1/8")	500pcs
SL3H1K	3mm(1/8")	1000pcs

Spin Level Cap

- ▲ Holds tiles level
- ▲ Ideal for walls & floors
- ▲ Eliminates lippage on uneven tiles

Art.No	Size	Qty
SLC100	Universal	100pcs





Tornado Fast Clip Cap

- ▲ Fast clip design, faster than ever
- ▲ Holds tiles level
- ▲ Ideal for walls & floors
- ▲ Eliminates lippage on uneven tiles

Art.No	Size
BLTF100	universal

210



Tornado Base 1mm

- ▲ Holds tiles level up to 18mm
- ▲ Ideal for walls & floors
- ▲ Eliminates lippage on uneven tiles

Art.No	Size	Qty
BLT1100	1mm(1/32")	100pcs
BLT1250	1mm(1/32")	250pcs
BLT11K	1mm(1/32")	1000pcs

Tornado Base 1.5mm

- ▲ Holds tiles level up to 18mm
- ▲ Ideal for walls & floors
- ▲ Eliminates lippage on uneven tiles

Art.No	Size	Qty
BLT2100	1.5mm(1/16")	100pcs
BLT2250	1.5mm(1/16")	250pcs
BLT21K	1.5mm(1/16")	1000pcs

Tornado Base 3mm

- ▲ Holds tiles level up to 18mm
- ▲ Ideal for walls & floors
- ▲ Eliminates lippage on uneven tiles

Art.No	Size	Qty
BLT3100	3mm(1/8")	100pcs
BLT3250	3mm(1/8")	250pcs
BLT31K	3mm(1/8")	1000pcs

HOW TO USE



1 Place the level base under the tiles 10 cm from either end
 2 Apply the fast clip cap to the level base
 3 Close the cap and spin down to the required level to ensure no lippage
 4 Remove the cap with BIHUI rubber mallet and open the cap simply for reuse





Horseshoe Shim

- ▲ High impact reusable plastic shim
- ▲ For both horizontal and vertical tile installation
- ▲ Easy to install & Easy to remove
- ▲ For aligning marble, granite, porcelain and large format tile

Art.No	Size	Qty
HSB400	1.5mm 1/16"	400pcs
HSP350	2mm 5/64"	350pcs
HSR300	3mm 1/8"	300pcs
HSY220	5mm 3/16"	220pcs
HSB150	6mm 1/4"	150pcs

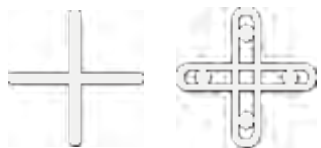

Tile Spacers

- ▲ 250 pieces per reseal bag
- ▲ Ideal for wall and floor tiles

Art.No	Size	Qty
TSC1250	1mm 1/32"	250pcs
TS15250	1.5mm 1/16"	250pcs
TSC2250	2mm 5/64"	250pcs
TSC3250	3mm 1/8"	250pcs
TSC5250	5mm 3/16"	250pcs



Tile Spacers

- ▲ 250 pieces per reseal bag
- ▲ Ideal for wall and floor tiles

Art.No	Size	Qty
TST2250	2mm 5/64"	250pcs
TST3250	3mm 1/8"	250pcs
TST4250	4mm 5/32"	250pcs
TST5250	5mm 3/16"	250pcs



Multi Size Spacer

- ▲ 50pcs per reseal bag
- ▲ Reusable
- ▲ Ideal for wall and floor tiles

Art.No	Size	Qty
TSM50	4 in 1	50pcs



Rotate Wedge

- ▲ 50pcs per reseal bag
- ▲ Reusable
- ▲ Ideal for wall and floor tiles

Art.No	Size	Qty
TSR50	1-13mm (1/32")-(1/2")	50pcs



Tile Wedge

- ▲ 250pcs per reseal bag
- ▲ Ideal for wall and floor tiles

Art.No	Size	Qty
TSW250	0,5-5mm (1/64")-(3/16")	250pcs





Switchable Pro-Long Notched Trowel Set

- ▲ 2pcs x Switchable soft handle
- ▲ 6pcs x Stainless steel spare blades in 480x130mm
- ▲ Notched 6,8,10,12mm, Tiger notch and Diagonal notch
- ▲ Durable storage and drain box

Art.No	Size	Notch Guide
PTSJK9	480x130mm (19"x5-1/8")	6mm(1/4") SQ notch
		8mm(5/16") SQ notch
		10mm(3/8") SQ notch
		12mm(1/2") SQ notch
		Diagonal notch
		Tiger notch

Switchable Jumbo Notched Trowel Set

- ▲ 2pcs x Switchable soft grip handle
- ▲ Switch between trowel blades to be used both right and left handed
- ▲ 6pcs x Stainless steel blades in 280x115mm
- ▲ Notched 6,8,10,12mm, Tiger notch and 10x20mm Round Notch
- ▲ 6pcs x Stainless steel blades in 480x130mm
- ▲ Notched 6,8,10,12mm, Tiger notch and Diagonal notch
- ▲ Storage and drain box for 280x115mm blades
- ▲ Professional trowel set and saves storage space



Art.No	Size	Notch Guide
PTSJK15	280x115mm (11"x4-1/2")	6mm(1/4") SQ notch
		8mm(5/16") SQ notch
		10mm(3/8") SQ notch
		12mm(1/2") SQ notch
		10x20mm(3/8"x3/4") Round Notch
		Tiger notch
PTSJK15	480x130mm (19"x5-1/8")	6mm(1/4") SQ notch
		8mm(5/16") SQ notch
		10mm(3/8") SQ notch
		12mm(1/2") SQ notch
		Diagonal notch
		Tiger notch

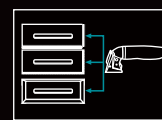
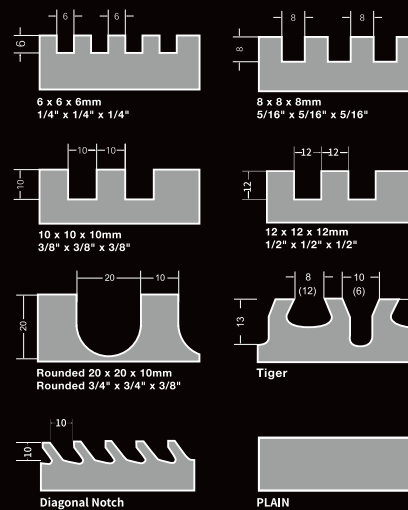

Easy-Attach
Switch between floats and trowels with the convenience of only one handle.

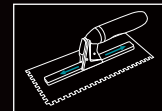

Slide-Lock Handle
For secure and adjustable placement along trowels and floats.

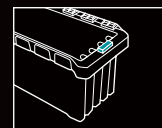

Blade Lock
Stores trowel and floats securely.

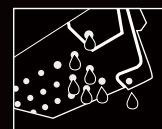

Drain System
Leaves your blades and floats dry while in storage.



Switchable Notched Trowel Set

- ▲ Stainless Steel Blades 280x115mm
- ▲ Switchable blade 6pcs in different notches
- ▲ Switchable TPR handle
- ▲ Durable storage and drain box

Art.No	Size	Notch Guide
PTSJG8	280x115mm (11"x4-1/2")	6mm(1/4") SQ notch
		8mm(5/16") SQ notch
		10mm(3/8") SQ notch
		12mm(1/2") SQ notch
		10x20mm(3/8"x3/4") Round Notch
		Tiger notch

Art.No	Size	Notch Guide
PTSJA8	280x115mm (11"x4-1/2")	3.2mm(1/8") SQ notch
		4.5mm(3/17") SQ notch
		6mm(1/4") SQ notch
		12mm(1/2") SQ notch
		6x12x20mm(1/4"x1/2"x3/4") U Notch
		Tiger notch



Switchable Handle
▲ Suitable for BIHUI Switch System pads and blades etc.
▲ Quick lock & release clamp
Art.No: PTSJHD



Switchable Blade
▲ #420 Stainless Steel
▲ Different notches available
▲ Size: 280x115mm(11"x4-1/2")
Art.No: PTSJ series



Switchable Blade
▲ #420 Stainless Steel
▲ Different notches available
▲ Size: 480x130mm(19"x5-1/8")
Art.No: PTSJL series



NOTCHED TROWEL



Storage Box with Switch Handle

- ▲ Switchable soft handle
- ▲ Quick lock and release clamp
- ▲ Durable storage and drain box
- ▲ Suitable for BIHUI Switch System pads and blades etc.
- ▲ Pick any blades (up to 6) you like to fill the box
- ▲ Switch Handle and Storage Box Included
- ▲ More than 10+ notch sizes available for choosing

Art.No	Size	
PTSJHB	280x115mm	11"x4-1/2"

Replacement Switchable Blade

- ▲ Stainless steel blade
- ▲ Durable aluminum rail
- ▲ For use with BIHUI switchable soft handle
- ▲ Special notch for flooring job

Art.No	Size	Notch Guide
PTQACT4	290x110mm (11-3/8"x4-3/8")	1.5x1.5x1.5mm (1/16"x1/16"x1/16")
PTQFCA4		1.5x1.5x1.5mm (1/16"x1/16"x1/16")
PTQFFA4		1.5x1x1mm (1/16"x1/32"x1/32")
PTQFFA4		1.5x3x3mm (1/16"x1/8"x1/8")
PTQFOW4	290x110mm (11-3/8"x4-3/8")	1.5x3x3mm (1/16"x1/8"x1/8")
PTQFOW4		2.5 x 2.5 x 2.5mm (3/32" x 3/32" x 3/32")
PTQRCA4	290x110mm (11-3/8"x4-3/8")	2.5 x 2.5 x 2.5mm (3/32" x 3/32" x 3/32")
PTQRCA4		1.5x2x1mm (1/16"x5/64"x1/32")
PTQWHA4	290x110mm (11-3/8"x4-3/8")	1.5x2x1mm (1/16"x5/64"x1/32")
PTQWHA4		1.5x2x1mm (1/16"x5/64"x1/32")

Notched Trowel

- ▲ Contoured handle improves control and comfort
- ▲ Handle fastened to blade with 6 screwed
- ▲ 0.6mm quality stainless steel
- ▲ Range of notch size to suit any job

Art.No	Size	Notch Guide
PTSS06	280x115mm (11"x4-1/2")	6mm(1/4") SQ notch
PTSS08		8mm(5/16") SQ notch
PTSS10		10mm(3/8") SQ notch
PTSS12		12mm(1/2") SQ notch
PTSSTG		Tiger notch

Notched Trowel

- ▲ Contoured handle improves control and comfort
- ▲ Handle fastened to blade with 6 welded rivets
- ▲ 0.6mm quality stainless steel blade
- ▲ Range of notch size to suit any job

Art.No	Size	Notch Guide
PTCD06	280x115mm (11"x4-1/2")	6mm(1/4") SQ notch
PTCD08		8mm(5/16") SQ notch
PTCD10		10mm(3/8") SQ notch
PTCD12		12mm(1/2") SQ notch
PTCDTG		Tiger notch



Art.No	Size	Notch Guide
PTFACT4	280x115mm (11"x4-1/2")	1.5x1.5x1.5mm (1/16"x1/16"x1/16")
PTFFCA4		1.5x1.5x1.5mm (1/16"x1/16"x1/16")
PTFFFA4		1.5x1x1mm (1/16"x1/32"x1/32")
PTFFOW4		1.5x3x3mm (1/16"x1/8"x1/8")
PTFRCA4		2.5 x 2.5 x 2.5mm (3/32" x 3/32" x 3/32")
PTFRCA4		2.5 x 2.5 x 2.5mm (3/32" x 3/32" x 3/32")
PTFWHA4		1.5x2x1mm (1/16"x5/64"x1/32")
PTFWHA4		1.5x2x1mm (1/16"x5/64"x1/32")



Jumbo Notched Trowel

- ▲ Heavy duty trowel with 290mm durable rails
- ▲ Metal close handle for perfect balance and extra comfort
- ▲ Handle fastened to blade with 12 welded rivets
- ▲ 0.8mm quality stainless steel blade
- ▲ Range of notch sizes available to suit any job

Art.No	Size	Notch Guide
PTSM08	480x120mm (19"x4-3/4")	8mm(5/16") SQ notch
PTSM10		10mm(3/8") SQ notch
PTSM12		12mm(1/2") SQ notch
PTSM15		15mm(19/32") SQ notch
PTSM20		20mm(3/4") SQ notch
PTSMPL		Plain



Notched Trowel

- ▲ Contoured handle for improved comfort and control
- ▲ Handle support held to blade with 13 mounted rivets
- ▲ 0.7mm quality stainless steel blade
- ▲ Range of notch size to suit any job

Art.No	Size	Notch Guide
PTSL06	320x120mm (12-1/2"x4-3/4")	6mm(1/4") SQ notch
PTSL08		8mm(5/16") SQ notch
PTSL10		10mm(3/8") SQ notch
PTSL12		12mm(1/2") SQ notch
PTSLTG		Tiger notch
PTSLTG		Tiger notch



Notched Trowel

- ▲ Contoured handle improves control and comfort
- ▲ Handle fastened to blade with 8 mounted rivets
- ▲ 0.7mm quality stainless steel blade
- ▲ Range of notch size to suit any job

Art.No	Size	Notch Guide
PTSB03	280x120mm (11"x4-3/4")	3mm(1/8") SQ notch
PTSB04		4mm(5/32") SQ notch
PTSB06		6mm(1/4") SQ notch
PTSB08		8mm(5/16") SQ notch
PTSB10		10mm(3/8") SQ notch
PTSB12		12mm(1/2") SQ notch
PTSB20		Round Notch
PTSBTG		Tiger notch
PTSBPL	Plain	



BRICKLAYING TROWEL



Plasters Trowel

- ▲ Stainless Steel #420
- ▲ Soft grip handle

Art.No	Size
BTSHP4	100mm 4"



Gauging Trowel

- ▲ High strength carbon steel
- ▲ Soft grip handle

Art.No	Size
BTCHG7	180mm 7"



Tuck Pointer

- ▲ High strength carbon steel
- ▲ Soft grip handle

Art.No	Size
BTCHT08	8mm 5/16"
BTCHT10	10mm 3/8"
BTCHT12	12mm 1/2"



Margin Trowel

- ▲ High strength carbon steel
- ▲ Soft grip handle

Art.No	Size
BTCHM5	125mm 5"



Gauging Trowel

- ▲ High strength carbon steel
- ▲ Soft grip handle

Art.No	Size
BTCHG6	180mm 7"
BTCHG8	200mm 8"



Bucket Trowel

- ▲ High strength carbon steel
- ▲ Soft grip handle

Art.No	Size
BTCHB4	120mm 4-3/4"
BTCHB5	140mm 5-1/2"
BTCHB6	160mm 6-3/8"
BTCHB7	180mm 7"



Tile Remover Scraper

- ▲ Ideal for removing tiles and adhesives
- ▲ 1.2mm thick steel blade
- ▲ Rubber pro grip handle
- ▲ Steel cap for extra strength

Art.No	Size
TRSC4	100mm 4"



Professional Taping Knife

- ▲ Stainless steel with mirror-polished for easy cleanup
- ▲ Lightweight, ergonomically designed handle for all-day use

Art.No	Size
PTK22	220mm 8-5/8"
PTK30	300mm 12"
PTK50	500mm 20"
PTK60	600mm 24"
PTKNQ6	600mm 24"



Bucket Scoop

- ▲ Curved blade design for clean removal of materials
- ▲ Designed to fit most mixing and grouting buckets

Art.No	Size
PTK165	165mm 6-1/2"



Putty Scraper

- ▲ One piece design with soft cover
- ▲ #420 Stainless steel
- ▲ Fine polished soft blade

Art.No	Size	Art.No	Size
PTS1NH	38mm 1-1/2"	PTS6	150mm 6"
PTS2	50mm 2"	PTS8	200mm 8"
PTS3	75mm 3"	PTS10	250mm 10"
PTS4	100mm 4"	PTS10IN1	75mm 3"
PTS5	125mm 5"		



Switchable Putty Scraper Kit

- ▲ One handle - 5 blades
- ▲ Premium switchable handle for all blades
- ▲ With strong steel hammer end
- ▲ Stainless steel #420
- ▲ Blades in 1.5", 4", 5", 6", 5N1

Art.No	Size
PTKSK6	6pcs kit



Tile Remover Scraper

- ▲ Ideal for removing tiles and adhesives
- ▲ 1.2mm thick steel blade
- ▲ Rubber pro grip handle
- ▲ Steel cap for extra strength

Art.No	Size
TRSC4	100mm 4"



Professional Taping Knife

- ▲ Stainless steel with mirror-polished for easy cleanup
- ▲ Lightweight, ergonomically designed handle for all-day use

Art.No	Size
PTK22	220mm 8-5/8"
PTK30	300mm 12"
PTK50	500mm 20"
PTK60	600mm 24"
PTKNQ6	600mm 24"



Bucket Scoop

- ▲ Curved blade design for clean removal of materials
- ▲ Designed to fit most mixing and grouting buckets

Art.No	Size
PTK165	165mm 6-1/2"



Professional Skimming Scraper Kit

- ▲ Ergonomic PVC handle
- ▲ Flexible 0.5mm stainless steel blade
- ▲ Including wall scrapers in 250mm, 400mm, 600mm, 800mm, 1000mm
- ▲ Telescope handle in 1100mm
- ▲ Spare connection handle
- ▲ Nylon paint roller in 220mm

Art.No	Size
PTKJK8	Universal





The World's First Switch System for grouting & cleaning tools and trowel blades

PATENTED



Switchable Grouting & Cleaning System

- ▲ 12pcs kit for grouting and cleaning
- ▲ 1 x sponge float pad
- ▲ 1 x EVA grouting pad
- ▲ 1 x flexible rubber pad
- ▲ 1 x green epoxy pad
- ▲ 5 x notched blades
- ▲ 1 x interchangeable handle
- ▲ 1 x interchangeable soft handle
- ▲ 1 x tool box

NEW



Art.No	Size
PTSGK12	12pcs



Switchable Soft Handle

- ▲ Suitable for BIHUI Switch System pads and blades etc.
- ▲ Quick lock & release clamp

Art.No	Size
PTSGSH	220x68mm

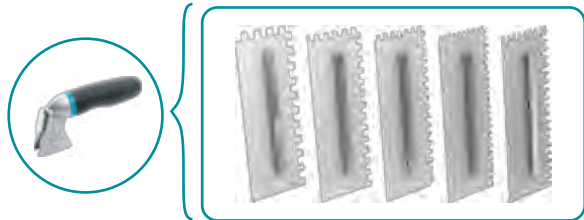

Sponge Float Pad

- ▲ Use with switchable soft handle
- ▲ Hydro sponge with block cut
- ▲ Ideal for all types of cleaning and decorating

Art.No	Size
PTSGSG	280x140x30mm (11"x5-1/2"x1-3/16")



Cellulose Float Pad

- ▲ Use with switchable soft handle
- ▲ 100% Cellulose
- ▲ Ideal for all types of cleaning and decorating

Art.No	Size
PTSCSP	280x140x30mm (11"x5-1/2"x1-3/16")



EVA Grout Float Pad

- ▲ Use with switchable soft handle
- ▲ Ideal for all types of cleaning and decorating

Art.No	Size
PTSEVA	280x140x8mm (11"x5-1/2"x5/16")



Cleaning Pads

- ▲ Use with switchable soft handle
- ▲ Excellent for the removal of grout or adhesive from tile surfaces
- ▲ Including 3 pads in super fine, medium and coarse

Art.No	Size
PTSCNP	250x120mm (10"x4-3/4")



Grout Float Pad

- ▲ Use with switchable soft handle
- ▲ Aluminium base with high density EVA
- ▲ Rubber pad

Art.No	Size
PTSGRF	240x100mm (9-3/8"x4")



Epoxy Grout Float Pad

- ▲ Use with switchable soft handle
- ▲ Green hard rubber

Art.No	Size
PTSEPX	248x116mm (10"x4-1/2")



Smart 19L
Trade washy bucket



19L Tile Washing Set

- ▲ Durable bucket with wheels and stands
- ▲ Arc-shaped pouring edge and ergonomic handle
- ▲ Triple rollers for fast water extraction
- ▲ Heavy duty plastic grid, stay still in place
- ▲ Soft grip sponge float with block cut
- ▲ Soft grip EVA float with high density
- ▲ Ideal for cleaning floor and wall tiles & applying grouts

Art.No	Description
TWS19	6pcs kit
TWS19A	4pcs kit
TWS19G	Grid
TWS19R	Roller



Durable Plastic grid



Tri-roller, triple efficiency



Arc-Shaped Edge



Rotary wheels and anti-slip stands



Epoxy Grout Float

- ▲ Green hard rubber

Art.No	Size
CFHRL	248x116mm (10"x4-1/2")



Grout Float

- ▲ Soft grip handle
- ▲ Aluminium base with high density EVA
- ▲ Rubber pad

Art.No	Size
CFERS	240x100mm (9-3/8"x4")



Epoxy Red Float

- ▲ Solid thermoplastic rubber pad in 12mm
- ▲ Durable with TPR handle

Art.No	Size
CFSRS	89x254mm (3.5"x10")

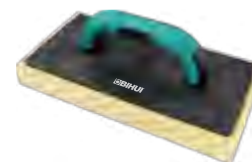

Professional Sponge Float

- ▲ Soft grip handle
- ▲ Hydro sponge with block cut

Art.No	Size
CFHSS11	280x140x30mm (11"x5-1/2"x1-3/16")



EVA Grout Float

- ▲ Soft grip handle

Art.No	Size
CFES11	280x140x8mm (11"x5-1/2"x5/16")



Cleaning Pads

- ▲ Excellent for the removal of grout or adhesive from tile surfaces
- ▲ Including 3 pads in super fine, medium and course

Art.No	Size
CSPK4	250x120mm (10"x4-3/4")
CSPB	250x120x20mm (10"x4-3/4"x3/4")
CSPW	250x120x20mm (10"x4-3/4"x3/4")



Hydro Grouting Sponge

- ▲ Soft and absorbent
- ▲ Ideal for all types of cleaning and decorating
- ▲ Round polished edges

Art.No	Size
CFHS190	190x140x51mm (7-5/8" x 5-1/2" x 2")



Hydro Scrubbing Sponge

- ▲ Dual combination with hydro sponge
- ▲ Round polished edges

Art.No	Size
CFHC180	180x110x65mm (7" x 4-4/8" x 2-1/2")



Economy Grouting Sponge

- ▲ Ideal for cleaning tiles after grouting
- ▲ Extremely absorbent
- ▲ High abrasion resistance

Art.No	Size
CFSV25	190x140x50mm (7-5/8" x 5-1/2" x 2")
CFSV100	180x110x50mm (7-5/8" x 5-1/2" x 2")

COMING SOON



Hydro Grouting Sponge

- ▲ Ideal for cleaning tiles after grouting

Art.No	Size
CFHS165	165x110x60mm (6-1/2" x 4-3/8" x 2-3/8")



Brown Hydro Sponge

- ▲ Ideal for cleaning tiles after grouting

Art.No	Size
CFHB160	160x100x60mm (6-3/8" x 4" x 2-3/8")



Cellulose Sponge

- ▲ 100% Cellulose
- ▲ Ideal for all types of cleaning and decorating

Art.No	Size
CFCS165	165x110x50mm (6-1/2" x 4-3/8" x 2")
CFCS180	180x110x50mm (7" x 4-3/8" x 2")



Microfiber Sponge

- ▲ Dual combination with hydro sponge
- ▲ Round polished edges

Art.No	Size
CFHM190	190x120x50mm (7-1/2" x 4-3/4" x 2")



Compound Tile Nipper

- ▲ Triple Power - same effort
- ▲ Comfort grip handle
- ▲ Maximum tile thickness 12mm
- ▲ Ideal for irregular cuts in ceramic and porcelain tile

Art.No	Size
TNC10	250mm 10"



Straight Tile Nipper

- ▲ Designed to form narrow strips and shapes from wall or floor tiles
- ▲ Drop forged
- ▲ Carbide tipped-straight jaw
- ▲ Soft grip handle

Art.No	Size
TND8	200mm 8"



Breaking Tile Nipper

- ▲ A dual purpose tool for cutting and breaking small wall tiles
- ▲ Carbide wheel, metal construction
- ▲ Comfort grip handle

Art.No	Size
TNB8	200mm 8"



Multifunction Trim Puller

- ▲ Plastic handle and stainless steel blade
- ▲ Lighter weight and compact size stop damages to the wall
- ▲ Designed for baseboard, trim molding, chair railing, decorative panel etc.

Art.No	Size
FTP100	270x100x80mm (11" x 4" x 3-9/64")



Dust Door "U"

- ▲ To prevent dust and smell during decoration
- ▲ Suitable for 1M wide door
- ▲ Fast and easy setup
- ▲ Made of clear and strong HDPE plastic

Art.No	Size
TDZD	112x220cm (44-3/32" x 86-5/8")





Wall Tile Leveling Lifter

- ▲ Convenient adjustment allows for 1-20cm free height adjustment
- ▲ Quick release level for minor adjust and removal
- ▲ Single loading capacity is 80Kg
- ▲ Ideal for facilitating the laying of large tiles on the wall

Art.No	Size
TAS25	1-20cm



Level Pegs

- ▲ High strength self-adhesive backing
- ▲ Flexible vinyl material
- ▲ 10pcs per stripe
- ▲ Designed to achieve a level and consistent surface when pouring self-leveling and cementitious flooring materials

Art.No	Size
MSLP100	10-100mm



Tiler's Gloves

- ▲ Provides excellent grip and movement when handling tile and stone
- ▲ Wear-resistant, stain-resistant
- ▲ Elastic ventilate, comfortable

Art.No	Size
TGDL	9 / L
TGDXL	10 / XL
TGDXXL	11 / XXL



Automatic Pencil Marker

- ▲ Comes with 1 black lead and 6 spare leads: black, red, white available
- ▲ Writes on most surfaces including metal, timber, plastics, bricks, blocks & glass
- ▲ Integrated lead sharpener built into the cap
- ▲ Belt clip & Interchangeable lead
- ▲ Made from high quality ABS stainless steel materials

Art.No	Size	
TCM7	150mm	6"
TCM7-SL	150mm	6"



Tile Markers

- ▲ Black, White and Red
- ▲ For marking on variety of surfaces for cutting and drilling jobs

Art.No	Size	
TCM3	180mm	7"



Profile Gauge with Lock

- ▲ Utilizing individually tensioned
- ▲ Low friction plastic blades
- ▲ With blade locking system
- ▲ Magnetic for hands-free working
- ▲ Metric and imperial scale

Art.No	Size	
TPL250	250mm	10"



Anti-vibration Gloves

- ▲ Universal size to fit all
- ▲ Anti-vibration design with thick cushion rubber

Art.No	Size
TGAVXL	250X115mm (10"x4-1/2")



Grout Rake

- ▲ With TPR soft grip handle
- ▲ Use to remove old grout between tiles
- ▲ 2 x tungsten carbide blades

Art.No	Size	
TGRS2	200mm	8"



Grout Rake Blades

- ▲ 2 x tungsten carbide blades
- ▲ For use with BIHUI Grout Rake

Art.No	Size
TGRSB2	Spare blades for TGRS2



Profile Gauge

- ▲ Quick and easy way to copy awkward shapes
- ▲ Utilizing individually tensioned
- ▲ Low friction plastic blades
- ▲ Ideal for tiling, wallpaper, laying carpet, laminate flooring

Art.No	Size	
TPG250	250mm	10"



Rubber Mallet

- ▲ Soft grip

Art.No	Size
RMWO24	24OZ



One Piece Rubber Mallet

- ▲ Comfort grip

Art.No	Size
RMWS24	24OZ



Tile Corner Protector

- ▲ 4pcs per pack
- ▲ Multiple uses
- ▲ Mitigates risk of tile damage

Art.No	Size	
LFTP06	6mm	1/4"
LFTP10	10mm	3/8"
LFTP13	13mm	33/64"



Grout and Sealant Repair Kit

- ▲ Finishing profiles with 3R(1/8R) and 6R(1/4R)
- ▲ Grouting nozzle for cartridge
- ▲ Silicone and sealant removing knives
- ▲ Quick and easy to use and clean

Art.No	Size
STARK3	Universal



Silicone Applicator Kit

- ▲ Has half round cut outs to create a quadrant seal
- ▲ Has straight cut edges to provide a triangular seal
- ▲ Easy to use tool, no need to tape or mask joints

Art.No	Size
STAK2	60x60mm (2-3/8")



Silicone Applicator Kit

- ▲ Finishing profiles in 0R,2R,3R,4R, 5R,6R,8R,10R,12R,14R,20R
- ▲ Easy to use, no need to tape or mask joints
- ▲ Designed to shape silicone sealant for a perfect neat finish

Art.No	Size
STAK4	46x46mm (1-3/4"x1-3/4")



Silicone Applicator Kit

- ▲ Finishing profiles in 3R,4.5R,6R,6.9,12,2C,3C,4C
- ▲ Ergonomic handle design provides better grip

Art.No	Size
STAK10	Universal



Caulking Gun

- ▲ Single Component Dispenser
- ▲ Mechanical thrust ratio: 26:1 & Stroke: 4mm
- ▲ Maximum force: 400kgf (3.9kN)
- ▲ Aluminum alloy handle & Steel trigger
- ▲ Patented 360° rotary type of steel riveted carriage
- ▲ Patented no trigger gaps design
- ▲ Suitable for cold weather and High viscosity materials

Art.No	Capacity
TCG310	310ml (10.5oz)



Caulking Gun

- ▲ Aluminum alloy die-casting material and metal drum
- ▲ Labor-saving handle design
- ▲ Anti-drip function
- ▲ Thrust 135kg
- ▲ The glue bucket can rotate 360 degrees
- ▲ Suitable for silicone and structural adhesives

Art.No	Capacity
TCG300	310ml (10.5oz)



Caulking Gun

- ▲ Aluminum alloy die-casting material and metal drum
- ▲ Labor-saving handle design
- ▲ Anti-drip function
- ▲ Thrust 135kg
- ▲ The glue bucket can rotate 360 degrees
- ▲ Suitable for silicone and structural adhesives"

Art.No	Capacity
TCG600	600ml (20.28oz)



Tile Repairing Kit

- ▲ With 16 blocks wax in most popular colors
- ▲ Perfect for repairing cracked tile, marble, ceramic walls and floor surfaces
- ▲ 1 x hot melt wax application tool
- ▲ 16 x hard wax sticks of different colors
- ▲ 1 x cleaning scraper
- ▲ 1 x textured scraper
- ▲ 1 x PU high-density sponge
- ▲ 1 x cleaning cloth
- ▲ 1 x Type-C charging cable

Art.No	Size
TRPK	5V - 1200mAh



Leather Knee Pads

- ▲ Soft and broad strap
- ▲ Single velcro front fastening strap
- ▲ Washable & durable
- ▲ Premium Grade Neoprene
- ▲ Heavy duty closed cell foam cushion

Art.No	Size
BLKP	Universal



Gel Knee Pads

- ▲ Foam core for maximum cushioning
- ▲ Gel cover for extra comfort
- ▲ Velcro straps & Pressure clip for added security
- ▲ Ergonomic design
- ▲ With great stability, preventing ligament and tendons fatigue

Art.No	Size
TKPG	Universal



TPR Knee Pads

- ▲ Waterproof and anti-slip engineered cover
- ▲ Made of breathable diving cloth and oxford fabric
- ▲ Durable reinforced stitching & extra foam core
- ▲ Soft gel core and thick cushioned foam core provides superior protection
- ▲ Easy & secure velcro fastening system
- ▲ Protects against nails, screws, glass and debris

Art.No	Size
TKPT	Universal



Gel Knee Pad Max

- ▲ Large coverage contacts to floor
- ▲ Gel pad for maximum cushion
- ▲ Elastic belt and buckle fasten
- ▲ Protects against nails and glass



Art.No	Size
TKPF	Universal



Uncoupling Mat Roller

- ▲ Max loading: 35kg(77lb)
- ▲ Extension handle to be 1.3-2m (40"-78")
- ▲ Used to embed the membrane full bond with mortar.
- ▲ Can be easier disassembled for transport and storage
- ▲ Reduces effort required to embed membrane

Art.No	Size
UMR330	1.3-2m (40"-78")

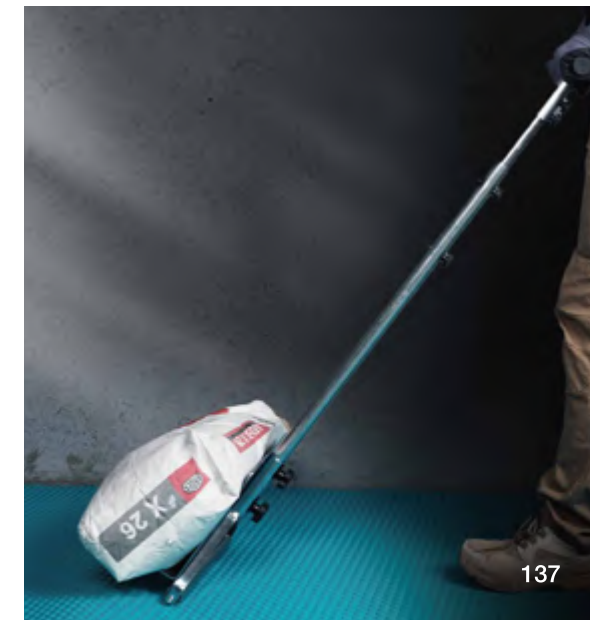
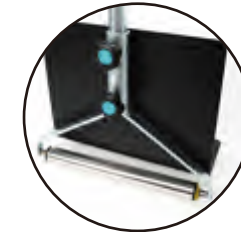

PROMOTIONAL ITEMS



Working Tent

Art.No	Size	
BPG10	3x3M	118"



Roll up

Art.No	Size	
BPG11	80x200cm	31-1/2"x78"



Display for Tile Spirit Level

Art.No	Size
TSL-DSP	400x632x295mm (15-3/4"x25"x12")



Display for TSL50

Art.No	Size
TSL50-DSP	400x210x1330mm (15-3/4"x8"x53-1/16")



Display for B-RIGID Leveling System

Art.No	Size
BLS-DSP	Universal



Hanging Poster

Art.No	Size	
BPG12	120x60cm	47-1/4"x24"



Bench Flag

Art.No	Size	
BPG09	2.8M	118"



Thermal Bottle 500ml

Art.No	Size
BPG19	265x70mm (10-1/4"x2-3/4")



Display for DBCW20

Art.No	Size
DBCW30-DSP	223x223x174mm (8-5/8"x8-5/8"x6-3/4")



Display for Diamond Tools

Art.No	Size
DBCW-DSP	Universal



Gift Bag

Art.No	Size
BPG17	35x37x15cm (1-3/8"x1-1/2"x19/31")



Pickleball Set

Art.No	Size
BPG18	Universal



Tool Storage Box

Art.No	Size
BPG16	Universal



Electric Skating Board

Art.No	Size
BPG20	Universal



- BPG01 Travel Case
- BPG02 Coffee Mug
- BPG03 Short Shirt
- BPG04 Baseball Cap
- BPG05 Calendar
- BPG06 Travel Bag
- TBD20 Tool Bag
- TFR20 Foldable Ruler





BDSP01 Display for tools
BDSH15 Hooks 5x150mm



BDSP02 Display for tile cutters



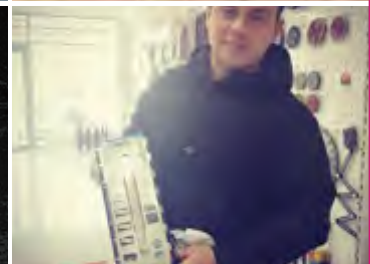

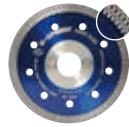

	DCDS	DCDW	DCDC	DCDM
	●	●		●
	●	●	●	●
Porcelain tiles	●	●	●	●
Ceramic Tiles	●	●	●	●
Slate	●			●
Marble				
Granite				
Terracotta	●	●	●	●
Concrete				
Glazed Clinker	●		●	
Hard tile			●	●
Slim Slab	●	●		●
Big Slab	●	●		●
Mosaic tiles	●		●	
Glass mosaic	●		●	
Stone				
Hard bricks				
45' cutting (O,X)		●	●	●
Cutting	●	●	●	●
Grinding				
Bevelling		●	●	●

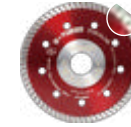

	DCDA	DCDT	DCDF	DCDV	DCDB
	●	●	●	●	●
	●	●			●
	●			●	●
	●			●	●
	●			●	●
		●			
			●		
	●	●			●
			●		
			●		
			●		
	●	●			●
	●	●	●	●	●
	●	●		●	●

* For your safety, don't use a cracking or damaged blade
 * Blue dot means best material for cutting
 * Black dot means suitable material for cutting
 * Blank means NOT suitable for cutting

ICONS AND CERTIFICATIONS

In order to provide the readers with clear and important information, we have used the following symbols





ICONS

















	DRY USE		READ THE MANUAL
	WET & DRY USE		READ THE MANUAL
	WET USE		CAUTION
	USE WITH DRILL MACHINE		CLASS II PROTECTION
	USE WITH ANGLE GRINDER		TANK VOLUME
	SUITABLE FOR PORCELAIN HARD TILES		MOTOR POWER
	SPEED (HIGH . MEDIUM)		NO OIL
	LIFETIME (LONG . MEDIUM)		NO FIRE
	PERFORMANCE (PERFECT . GOOD)		LITHIUM BATTERY RECYCLING LOGO
	BLADE DIAMETER		USE EYE PROTECTION
	BLADE BORE		ADHFDSHKFDH
	SEGMENT WIDTH		ADHFDSHKFDH
	SEGMENT THICKNESS		USE PROTECTIVE GLOVES
	SEGMENT WIDTH		RISK OF CUTTING
	45° CUTTING		USE OF SEGMENTED BLADES PROHIBITED
	CUTTING DIRECTION		DON'T USE FOR ANGLE CUTTING













CERTIFICATES

	CE MARK
	ETL MARK
	FDA MARK
	FCC MARK
	ROHS MARK
	TUV-GS MARK
	OSA
	EN13236

RECYCLING CODES

	PLASTIC BAGS
	CARDBOARD BOXES
	MAIL BOXES
	STICKER
	TRIMAN LOGO

	DON'T USE A CRACK BLADE
	NO WATER NEEDED
	RISK OF CUTTING
	SCORING WHEEL
	CUTTING LENGTH
	DIAGONAL CUTTING LENGTH
	THICKNESS
	BREAKING FORCE
	MACHINE WASH COLD
	DO NOT BLEACH
	DRY FLAT
	IRON ON MEDIUM HEAT
	DUST AND WATER PROTECTION
	CONFORMS TO WEEE
	INTERNATIONAL PATENTED
	PATENTED

	UV RESISTANT
	ANTI IMPACT
	HIGH PRECISION
	END PROTECTION
	DUST FULL INDICATOR
	SELF-CLEANING SYSTEM
	CABLE WINDING
	DRAIN DEVICE
	POWER TOOL SOCKET
	EASY STORAGE FOR ACCESSORIES
	WET & DRY CLEANING
	ESD PROTECTED
	PRESS ONCE, SUCK ON TILES

	PRESS TWICE, RELEASE AIR
	AUTOMATICALLY REPLENISH AIR
	USB CHARGER
	PRODUCT WEIGHT
	USE WITH BRICKLAYING TROWEL
	QUICK CHANGE ADAPTOR
	2 GEARS
	SPEED REGULATOR
	CORD WIRE
	MIXING PADDLE
	M14 THREAD
	WARNING LIGHTS
	MAX. DEPTH

	ANTI-SCRATCHING
	ALL IN ONE
	NO LIPPAGE
	REUSABLE
	INDOOR & OUTDOOR
	OSRAM LIGHT
	LASER CLASS 2
	DUST AND WATER PROTECTION
	TRIPOD
	SELF LEVELING
	LI-ION BATTERY
	3-IN-1 CHARGER